

# Kee Access<sup>®</sup>

RELIABLE SAFE ACCESS



## Kee Access<sup>®</sup> Ramp Instructions for Use Manual



## CONTENTS

<b>1. Important Information</b>	<b>Page 3</b>
<b>2. Basic Safety Instructions</b>	<b>Page 6</b>
<b>3. Components</b>	<b>Page 8</b>
<b>4. Module Types</b>	<b>Page 14</b>
<b>5. Assembly and Installation</b>	<b>Page 20</b>
<b>6. Kee Access Ramp System Recertification</b>	<b>Page 76</b>



# 1. IMPORTANT INFORMATION

## 1.1 Validity

These Instructions for Use apply to the following product:  
Type: Kee Access® ramp System  
Model Year: 2022

## 1.2 Authorised Agent

Kee Safety Limited  
Cradley Business Park  
Overend Road  
Cradley Heath  
B64 7DW  
Tel: +44 (0) 1384 632188  
E-Mail: sales@keesafety.com  
Internet: www.keesafety.co.uk

## 1.3 Compatibility

The Kee Access ramp system is designed to enable people who use wheelchairs, mobility scooters or other mobility aids to cross thresholds, such as doorways or kerbs safely where access would otherwise be difficult. The Kee Access ramp system can be retrofitted to existing buildings such as schools, public buildings or personal dwellings where ramped access is required either as a standalone product, or as part of a DDA/ADA compliant package including Kee Klamp handrails and guardrails.

## 1.4 Health and Safety

Installers and users must comply with all relevant health and safety regulations in their given territory.

## 1.5 Familiarisation

Before installing a Kee Access ramp for the first time, the installers are advised to attend a Kee Safety installation course.

## 1.6 Anticipated Life

Metal Components: Up to 25 years in non-marine, non-corrosive (e.g. chemical plant) environments with a temperature range from –10 to +55 degrees centigrade subject to use and a mandatory annual inspection strictly in accordance with these instructions.  
Nylon/Plastic Components: Up to 25 years in non-marine, non-corrosive (e.g. chemical plant) environments but may degrade past this with prolonged UV exposure and subject to use and a mandatory annual inspection strictly in accordance with these instructions. Plastics are fire-rated to ISO 11357-1/3.

## 1.7 Safeguarding the Instruction Manual

This Instructions for Use document forms a component part of the Kee Access ramp system. It must accompany the system and be followed for assembly. At no time must any pages be removed from these instructions. If the instructions are lost in their entirety or in part, the instructions or the missing parts must be replaced immediately.

## 1.8 Copyright

This documentation contains information protected by copyright. It may not be photocopied, reproduced, translated or recorded on data media, either completely or as extracts, without prior permission. We reserve all further rights.

## 1.9 Amendment Service

This document is not subject to any amendment service from the manufacturer. Amendments to this documentation can be carried out without prior notice.

## 1.10 Modifications to The Kee Access ramp system

If you undertake modifications to the Kee Access ramp system, you will negate all certification that comes with this product.

## 1.11 Definition “Authorised Person”

A person is deemed to be an authorised person if they have been authorised to work on or with the Kee Access ramp system in accordance with these instructions.

## 1.12 Definition “Trained Person”

Trained persons, are persons who, based on their specialist training and experience have adequate knowledge of the system to be checked and are sufficiently familiar with the relevant regulations, guidelines and generally recognised rules of the Kee Access ramp system and accompanying regulations - e.g., Health and Safety Regulations and Accident Prevention Regulations that are in force in the country of use; and can assess the safe working conditions of the installation location. A trained person shall be responsible for selecting all users of The Kee Access ramp system.

## 1.13 Use in Accordance with Regulations

The system provides a safe means of crossing thresholds and/or doorways by users of mobility equipment thus providing access into buildings where access would otherwise be difficult. The ramp system is designed as a permanently installed system. However, dismantling and reconstruction at a different location is permissible under certain circumstances.

The ramp system is only regarded as being used for its intended use if all the following conditions are met:

The ramp system is governed by various workplace Regulations and Guidelines. Operating personnel must be familiar with the statutory requirements arising from these.

## 1. IMPORTANT INFORMATION

They must also be familiar with and adhere to the following specifications and technical regulations:

- General requirements as dictated by local DDA/ADA codes
- The total weight of the ramp system depends on the length and configuration of the whole system and the load-bearing capacity of the flooring or area in which the ramp system is to be installed must at least correspond to the total weight of the system plus potential personnel. If in doubt, you must arrange for the substrate to which you are fixing to be examined by a structural engineer before assembly.
- The ramp system must be linked to the building's lightning protection system if possible, or earth bonded if used internally.
- The ramp system is only designed for use on those specified in the assembly instructions.
- Care should be taken to ensure that at all times the ramp system is clear of obstructions
- The installed surface must be free from algae, stones, oil, grease, water accumulation and loose debris.

### 1.14 Incorrect Use

The following points are classed as misuse:

- Use of the ramp system if one of the conditions specified under "intended use" is not met.
- Failure to observe the weights and conditions relating to the substrate specified under "intended use". If the conditions specified are not adhered to, then the ramp system may possibly fail.
- Use of a damaged ramp system or one which has been assembled incorrectly or is incomplete.
- Should the ramp system be used in spite of these instructions, then the possibility of a fall occurring and severe injury is possible.

**Use of The Kee Access ramp system in any of the above conditions is forbidden**

### 1.15 Operator's Duty of Care

The duties and obligations of the operator and trained personnel when dealing with The Kee Access ramp system are set out below.

#### Safety of The Kee Access ramp system

##### a) Safety of The Kee Access ramp system

In particular, the owner or employer must ensure that the ramp system is:

- Only used as intended.
- Is only provided in a fault-free reliable state.
- Is checked regularly.

##### b) Instruction and Training

All users of the system must ensure that:

- Before using the system for the first time and at least once annually thereafter, all personnel shall be instructed in all relevant matters of health and safety at work, public access and environmental protection.
- The instructions for use are always available in a legible state, are complete and are kept with the system at all times.
- All users are familiar with the contents of these instructions.

##### c) Duties of the User

The user must fulfil the following duties:

- Assemble The Kee Access ramp system strictly in accordance with this Instructions for Use Manual and check that the system is functioning correctly and safely.
- Recognise any defects and withdraw the system from use and alert the manufacturer so an assessment and required repairs can be completed.

##### c) Requirements of the User

In order to be able to fulfil his or her duties, the user must meet the following requirements:

- They must have adequate knowledge of the English language to understand these Instructions for Use. It is unlikely that any medical condition may directly affect (or be affected by) the use of this product in itself, but users must be aware that:
- Working at height or within a busy warehousing or industrial setting is a dangerous occupation.
- They should be trained to do so, and should comply with any medical requirements set by the training provider.

### 1.16 Atmospheric Conditions CARE TO BE EXERCISED!

**DANGER TO LIFE!** 

When the ramp system is installed externally it should be used with care during periods when there is frost, ice or snow in the vicinity, or if these conditions are imminent.

### 1.17 Contaminated Surfaces DANGER TO LIFE!

**DANGER TO LIFE!** 

Do not use the Kee Access ramp system if oil, grease or other lubricant, or growth of algae contaminates any part of the system.

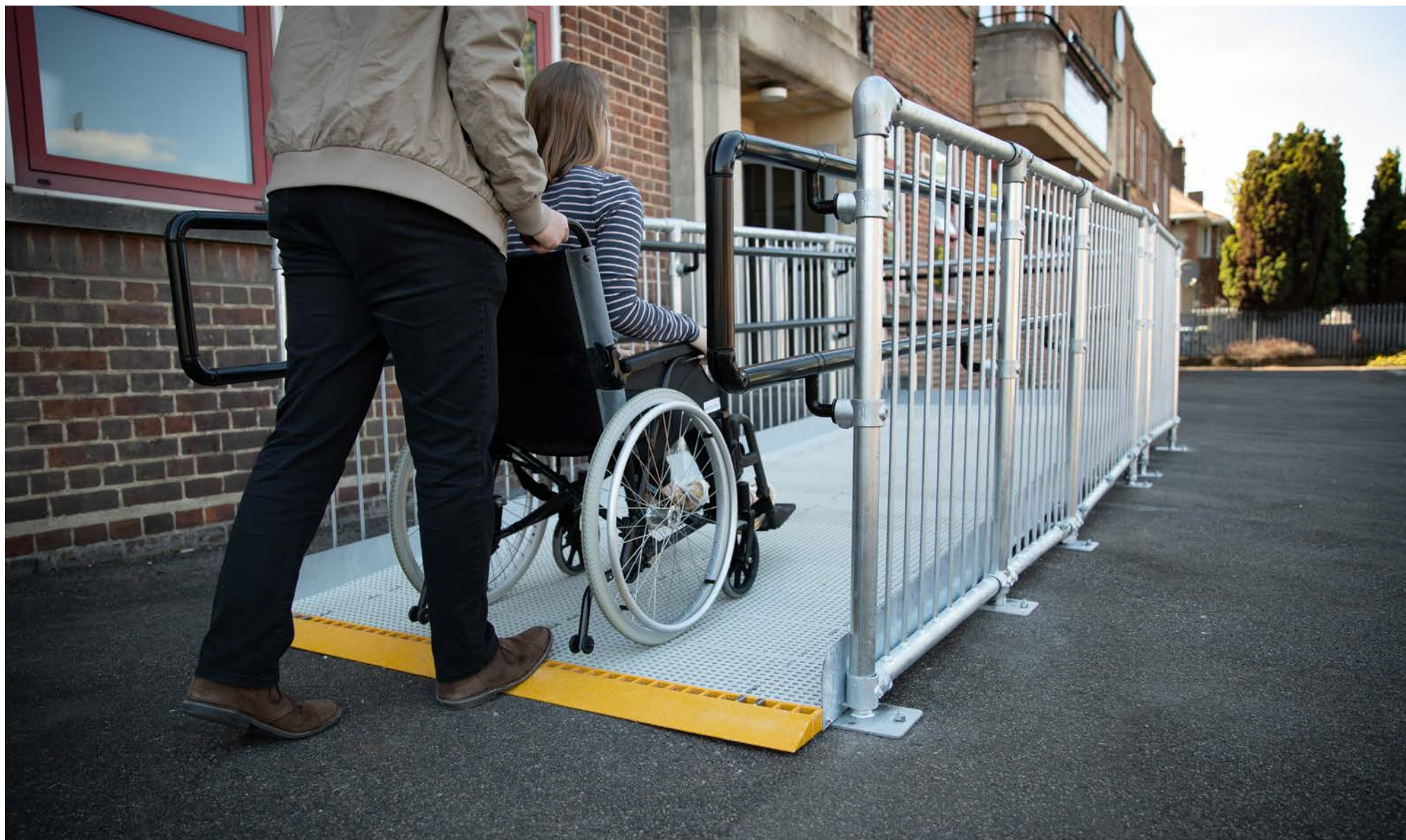

## 2. BASIC SAFETY INSTRUCTIONS

Basic safety instructions for the safe handling of the Kee Access ramp system can be found here.

**DANGER TO LIFE!** 

It is imperative that you follow these safety instructions to avoid endangering your life and safety.

### Possible Danger

#### **DANGER TO LIFE!**

There is a risk of the construction personnel falling during assembly or when carrying out repairs.

**Explanation:** Inadequate or insufficient safety measures or errors during the assembly of the ramp system can lead to falls resulting in severe/fatal injuries.

#### **DANGER TO LIFE!**

There is a risk of the ramp system failing if the installation site is unsatisfactory.

**Explanation:** A non-approved or substandard surface can result in ramp system being difficult/impossible to install

#### **DANGER TO LIFE!**

There is a risk of people falling due to failure to carry out maintenance work on the ramp System.

**Explanation:** Defects or damage can impair the function of the ramp system therefore the system may possibly not be guaranteed in the event of an emergency.

#### **DANGER TO LIFE!**

There is a risk of people falling due to attaching Personal Protection Equipment to a ramp system.

**Explanation:** The ramp system must never be used to attach PPE. to as an anchor for abseiling or similar work.

### Prevention Measures

- The ramp system is only to be assembled as specified in the assembly instructions.
- After assembly or after carrying out repairs, check all structural parts and connecting components to make sure that they are located correctly.
- Do not install the platform on any surfaces, either internal or external, that are damaged.
- Follow the detailed information on the installation sites for the ramp system in the assembly instructions.
- The target install surface must always be of the prescribed quality and load-bearing capacity.
- The prescribed measures must always be complied with.
- If you have to carry out repairs on the building or any ancillaries always carry out a visual check on the ramp system and the surrounding area beforehand for damage.
- Any parts that are found to be damaged. must always be replaced before any work is started.
- Only then is it permitted to enable the ramp system to be used
- The ramp system is a stand alone, building access system and should always be treated as such. Under no circumstances should the system be used as a “man anchor” or as a connection for PPE.

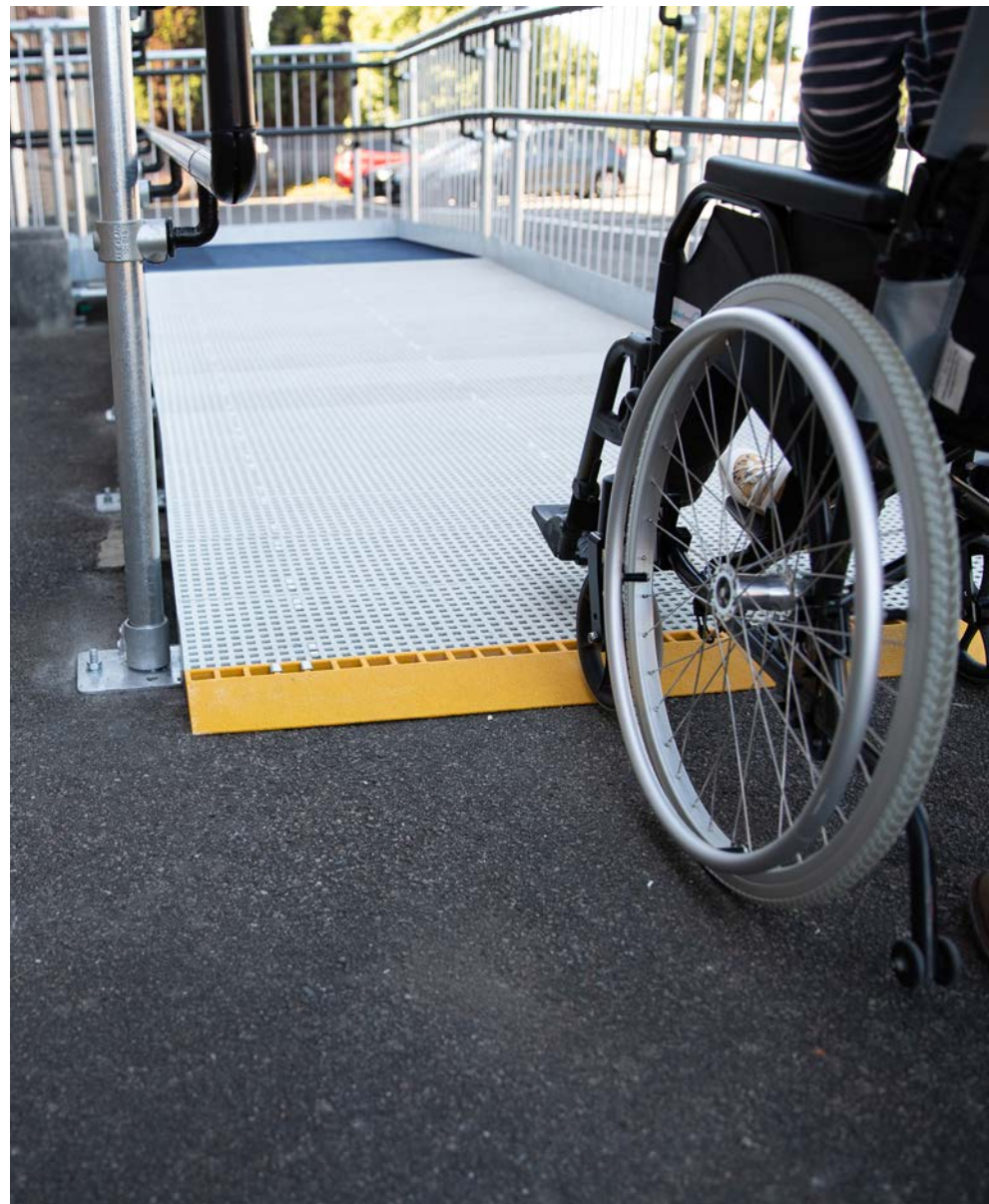
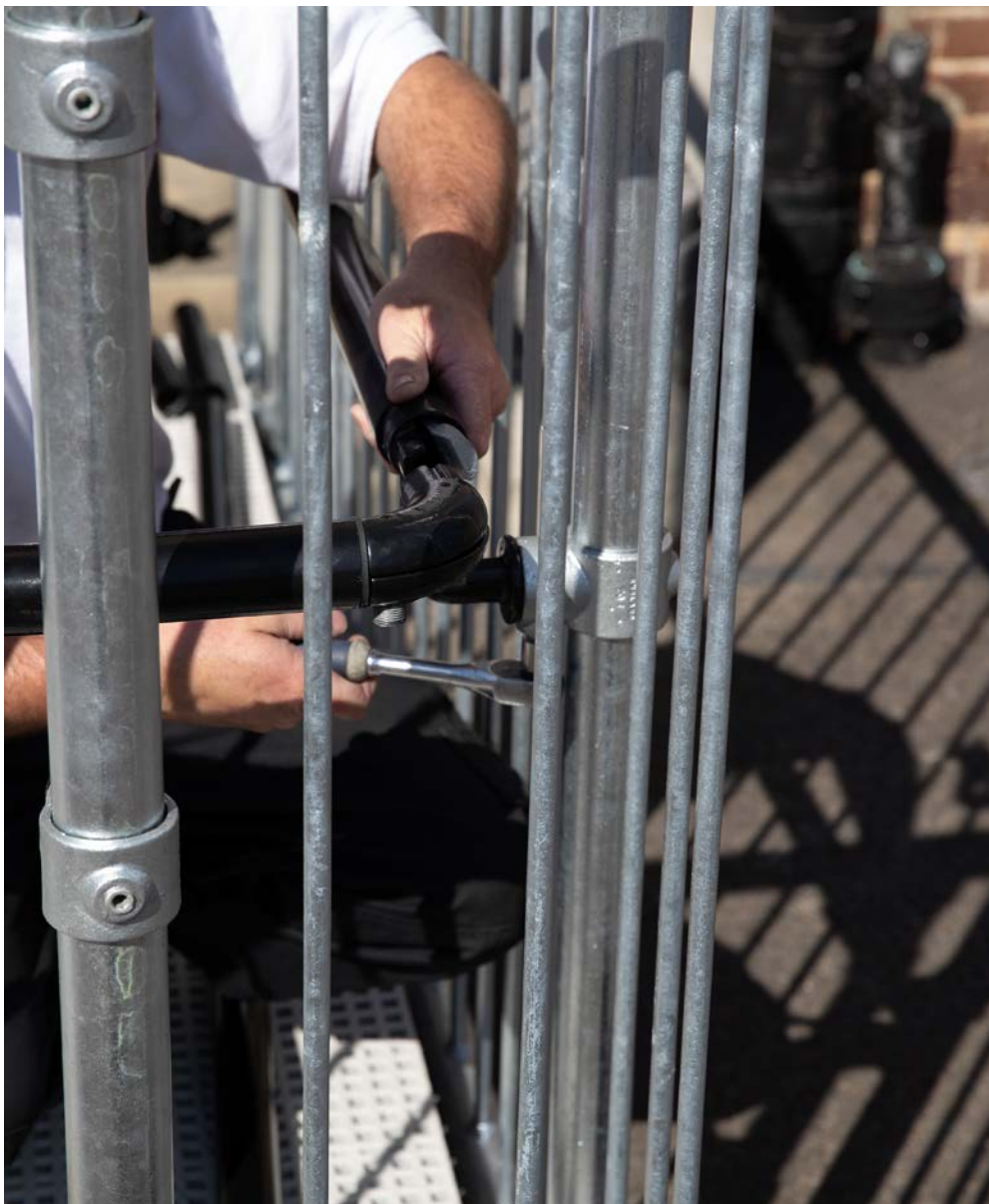

### 3. COMPONENTS

#### Designation and function of the components for standard systems

The ramp system consists of the following pre-assembled modules & individual components. The exact number of individual components depends on the length and construction of the ramp system. All fittings are cast from malleable cast iron to BS EN 1562 and galvanised to BS EN ISO 1461 and full part numbers for reference are detailed below.

**PC5757B10 - BLACK PC**  
Part No: PC5757B10



**PC5147B10 - BLACK PC**  
Part No: PC5147B10



**10-8 KEE KLAMP**  
Part No: 10-8



**PC5547B10 - BLACK PC**  
Part No: PC5547B10



**PC5157B10 - BLACK PC**  
Part No: PC5157B10



**A10-8 KEE KLAMP**  
Part No: A10-8



**PC5187B10 - BLACK PC**  
Part No: PC5187B10



**89-8 KEE KLAMP**  
Part No: 89-8





**Note:** A complete list of all parts and details on the total weight of the ramp system is provided with the delivery. The load-bearing capacity of the substrate must exceed the capacity specified.

**88-8 KEE KLAMP**  
Part No: 88-8



**20-8 KEE KLAMP**  
Part No: 20-8



**10-840C CAPPED**  
Part No: 10-840C



**87-8 KEE KLAMP**  
Part No: 87-8



**15-8 KEE KLAMP**  
Part No: 15-8



**26-8 KEE KLAMP**  
Part No: 26-8



**86-8 KEE KLAMP**  
Part No: 86-8



**10-848 DDA GALV**  
Part No: 10-848



**25-8 KEE KLAMP**  
Part No: 25-8



**35-8 KEE KLAMP**

Part No: 35-8



**72-8 KEE KLAMP**

Part No: 72-8



**508-7 KEEKLAMP**

Part No: 508-7



**59-8 KEE KLAMP**

Part No: 59-8



**114-8 KEE KLAMP**

Part No: 114-8



**500MM ADJUSTABLE GALV FOOT ASSEMBLY (SIZE 8)**

Part No: ADJ850010



**21-8 KEE KLAMP**

Part No: 21-8



**PC5207B10 - BLACK PC**

Part No: PC5207B10



**GRPCLIP50 - GRP TREAD RETAINING CLIP**

Part No: GRPCLIP50



**Note:** A complete list of all parts and details on the total weight of the ramp system is provided with the delivery. The load-bearing capacity of the substrate must exceed the capacity specified.

<p><b>GRP1212B60 - 1200 X 120 GRP TREAD - BLACK</b> Part No: GRP1212B60</p> 	<p><b>GRP1225B60 - 1221 X 235 GRP TREAD - BLACK</b> Part No: GRP1225B60</p> 	<p><b>GRP1225G60 - 1221 X 235 GRP TREAD - GREY</b> Part No: GRP1225G60</p> 
<p><b>GRP1525B60 - 1530 X 235 GRP TREAD - BLACK</b> Part No: GRP1525B60</p> 	<p><b>GRP1525G60 - 1530 X 235 GRP TREAD - GREY</b> Part No: GRP1525G60</p> 	<p><b>YELLOW GRP RAMP NOSING - 1221MM</b> Part No: GRPENT1260</p> 
<p><b>YELLOW GRP RAMP NOSING - 1530MM</b> Part No: GRPENT1560</p> 	<p><b>S/S SELF TAPPING SCREW FOR GRPCLIP50</b> Part No: GRPSCREW50</p> 	<p><b>WW3939 - RETAINING BRACKET ALUMINIUM</b> Part No: WW3939</p> 

## STRAIGHT CONNECTOR ALUM

Part No: WW1003



## TRHLD0030 - BOTTOM TREAD HOLDER

Part No: TRHLD0030



## 48.3MM O/D X 3.2MM WALL GALV TUBE BE EN39

Part No: 8-6-G



## 50 PER BAG, NO.10X20MM SS SADDLE FIXING SCREW

Part No: DDASCREW



## TRSB120010 - TREAD SUPPORT BAR

Part No: TRSB120010



## 42.4MM O/D X 3.2MM GALV TUBE BS EN10255

Part No: 7-2-G



## HEX HD STITCHING SCREW DIA 6.3 X 25

RUSPERT COATED Part No: WW6215



## TRSB150010 - TREAD SUPPORT BAR

Part No: TRSB150010



## EXTRUDED ALUMINIUM BEAM PER METRE

Part No: WW4040



**Note:** A complete list of all parts and details on the total weight of the ramp system is provided with the delivery. The load-bearing capacity of the substrate must exceed the capacity specified.

**VBI ANGLE CHANGE**

Part No: VB-ANG-FL-01/VB-ANG-FL-02

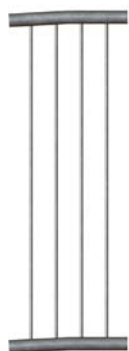

**VBI ANGLE**

Part No: VB1000310/VB1500310/VB2000310

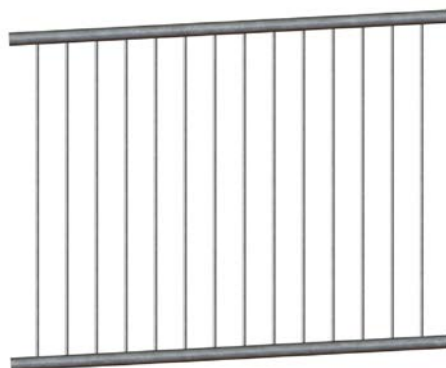

**VBI CORNER**

Part No: VB-CORN-IN/VB-CORN-IN-1200/  
VB-CORN-OUT



**VBI FLAT**

Part No: VB029001F/VB100001F/VB120001F/  
VB140001F/VB150001F/VB160001F/VB200001F

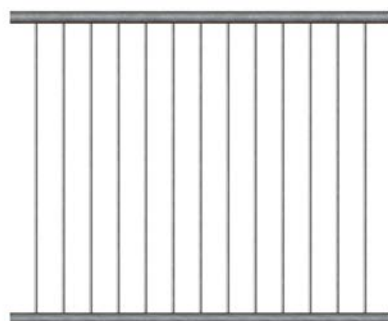

**VBI FRONT**

Part No: VB1000110/VB1000210

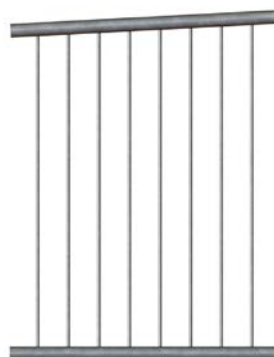

**VBI STAIRS**

Part No: VB040001S/VB060001S/VB080001S/  
VB100001S



## 4. MODULE TYPES



Long Part	Short Part	Description
KARST20V15	KAR01	KEE ACCESS RAMP - 2M START MODULE - 1500MM WIDE - C/W VBI
KARST20V12	KAR16	KEE ACCESS RAMP - 2M START MODULE - 1200MM WIDE - C/W VBI
KARST20N15	KAR31	KEE ACCESS RAMP - 2M START MODULE - 1500MM WIDE - NO INFILL
KARST20N12	KAR46	KEE ACCESS RAMP - 2M START MODULE - 1200MM WIDE - NO INFILL

Long Part	Short Part	Description
KARAN10V15	KAR02	KEE ACCESS RAMP - 1M ANGLED INTERMEDIATE MODULE - 1500MM WIDE - C/W VBI
KARAN15V15	KAR03	KEE ACCESS RAMP - 1.5M ANGLED INTERMEDIATE MODULE - 1500MM WIDE - C/W VBI
KARAN20V15	KAR04	KEE ACCESS RAMP - 2M ANGLED INTERMEDIATE MODULE - 1500MM WIDE - C/W VBI
KARAN10V12	KAR17	KEE ACCESS RAMP - 1M ANGLED INTERMEDIATE MODULE - 1200MM WIDE - C/W VBI
KARAN15V12	KAR18	KEE ACCESS RAMP - 1.5M ANGLED INTERMEDIATE MODULE - 1200MM WIDE - C/W VBI
KARAN20V12	KAR19	KEE ACCESS RAMP - 2M ANGLED INTERMEDIATE MODULE - 1200MM WIDE - C/W VBI
KARAN10N15	KAR32	KEE ACCESS RAMP - 1M ANGLED INTERMEDIATE MODULE - 1500MM WIDE - NO INFILL
KARAN15N15	KAR33	KEE ACCESS RAMP - 1.5M ANGLED INTERMEDIATE MODULE - 1500MM WIDE - NO INFILL
KARAN20N15	KAR34	KEE ACCESS RAMP - 2M ANGLED INTERMEDIATE MODULE - 1500MM WIDE - NO INFILL
KARAN10N12	KAR47	KEE ACCESS RAMP - 1M ANGLED INTERMEDIATE MODULE - 1200MM WIDE - NO INFILL
KARAN15N12	KAR48	KEE ACCESS RAMP - 1.5M ANGLED INTERMEDIATE MODULE - 1200MM WIDE - NO INFILL
KARAN20N12	KAR49	KEE ACCESS RAMP - 2M ANGLED INTERMEDIATE MODULE - 1200MM WIDE - NO INFILL



Long Part	Short Part	Description
KARAF00V15	KAR11	KEE ACCESS RAMP - ANGLED TO FLAT - 1500MM WIDE - C/W VBI
KARFA00V15	KAR12	KEE ACCESS RAMP - FLAT TO ANGLED - 1500MM WIDE - C/W VBI
KARAF00V12	KAR26	KEE ACCESS RAMP - ANGLED TO FLAT - 1200MM WIDE - C/W VBI
KARFA00V12	KAR27	KEE ACCESS RAMP - FLAT TO ANGLED - 1200MM WIDE - C/W VBI
KARAF00N15	KAR41	KEE ACCESS RAMP - ANGLED TO FLAT - 1500MM WIDE - NO INFILL
KARFA00N15	KAR42	KEE ACCESS RAMP - FLAT TO ANGLED - 1500MM WIDE - NO INFILL
KARAF00N12	KAR56	KEE ACCESS RAMP - ANGLED TO FLAT - 1200MM WIDE - NO INFILL
KARFA00N12	KAR57	KEE ACCESS RAMP - FLAT TO ANGLED - 1200MM WIDE - NO INFILL

Long Part	Short Part	Description
KARAF00V15	KAR11	KEE ACCESS RAMP - ANGLED TO FLAT - 1500MM WIDE - C/W VBI
KARFA00V15	KAR12	KEE ACCESS RAMP - FLAT TO ANGLED - 1500MM WIDE - C/W VBI
KARAF00V12	KAR26	KEE ACCESS RAMP - ANGLED TO FLAT - 1200MM WIDE - C/W VBI
KARFA00V12	KAR27	KEE ACCESS RAMP - FLAT TO ANGLED - 1200MM WIDE - C/W VBI
KARAF00N15	KAR41	KEE ACCESS RAMP - ANGLED TO FLAT - 1500MM WIDE - NO INFILL
KARFA00N15	KAR42	KEE ACCESS RAMP - FLAT TO ANGLED - 1500MM WIDE - NO INFILL
KARAF00N12	KAR56	KEE ACCESS RAMP - ANGLED TO FLAT - 1200MM WIDE - NO INFILL
KARFA00N12	KAR57	KEE ACCESS RAMP - FLAT TO ANGLED - 1200MM WIDE - NO INFILL



Long Part	Short Part	Description
KAR90RHV15	KAR13	KEE ACCESS RAMP - CENTRE RIGHT HAND TURN MODULE - 1500MM WIDE - C/W VBI
KAR90LHV15	KAR14	KEE ACCESS RAMP - CENTRE LEFT HAND TURN MODULE - 1500MM WIDE - C/W VBI
KAR90RHV12	KAR28	KEE ACCESS RAMP - CENTRE RIGHT HAND TURN MODULE - 1200MM WIDE - C/W VBI
KAR90LHV12	KAR29	KEE ACCESS RAMP - CENTRE LEFT HAND TURN MODULE - 1200MM WIDE - C/W VBI
KAR90RHN15	KAR43	KEE ACCESS RAMP - CENTRE RIGHT HAND TURN MODULE - 1500MM WIDE - NO INFILL
KAR90LHN15	KAR44	KEE ACCESS RAMP - CENTRE LEFT HAND TURN MODULE - 1500MM WIDE - NO INFILL
KAR90RHN12	KAR58	KEE ACCESS RAMP - CENTRE RIGHT HAND TURN MODULE - 1200MM WIDE - NO INFILL
KAR90LHN12	KAR59	KEE ACCESS RAMP - CENTRE LEFT HAND TURN MODULE - 1200MM WIDE - NO INFILL

Long Part	Short Part	Description
KAREN10V15	KAR05	KEE ACCESS RAMP - 1M FLAT END MODULE - 1500MM WIDE - C/W VBI
KAREN15V15	KAR06	KEE ACCESS RAMP - 1.5M FLAT END MODULE - 1500MM WIDE - C/W VBI
KAREN20V15	KAR07	KEE ACCESS RAMP - 2M FLAT END MODULE - 1500MM WIDE - C/W VBI
KAREN10V12	KAR20	KEE ACCESS RAMP - 1M FLAT END MODULE - 1200MM WIDE - C/W VBI
KAREN15V12	KAR21	KEE ACCESS RAMP - 1.5M FLAT END MODULE - 1200MM WIDE - C/W VBI
KAREN20V12	KAR22	KEE ACCESS RAMP - 2M FLAT END MODULE - 1200MM WIDE - C/W VBI
KAREN10N15	KAR35	KEE ACCESS RAMP - 1M FLAT END MODULE - 1500MM WIDE - NO INFILL
KAREN15N15	KAR36	KEE ACCESS RAMP - 1.5M FLAT END MODULE - 1500MM WIDE - NO INFILL
KAREN20N15	KAR37	KEE ACCESS RAMP - 2M FLAT END MODULE - 1500MM WIDE - NO INFILL
KAREN10N12	KAR50	KEE ACCESS RAMP - 1M FLAT END MODULE - 1200MM WIDE - NO INFILL
KAREN15N12	KAR51	KEE ACCESS RAMP - 1.5M FLAT END MODULE - 1200MM WIDE - NO INFILL
KAREN20N12	KAR52	KEE ACCESS RAMP - 2M FLAT END MODULE - 1200MM WIDE - NO INFILL





Long Part	Short Part	Description
KAREM25V15	KAR15	KEE ACCESS RAMP - 250MM END MODULE - 1500MM WIDE - C/W VBI
KAREM25V12	KAR30	KEE ACCESS RAMP - 250MM END MODULE - 1200MM WIDE - C/W VBI
KAREM25N15	KAR45	KEE ACCESS RAMP - 250MM END MODULE - 1500MM WIDE - NO INFILL
KAREM25N12	KAR60	KEE ACCESS RAMP - 250MM END MODULE - 1200MM WIDE - NO INFILL

Long Part	Short Part	Description
KARSCN0212	KAR61	KAR61 - RAMP STAIRCASE - 2 STEP - NO INFILL
KARSCN0312	KAR62	KAR62 - RAMP STAIRCASE - 3 STEP - NO INFILL
KARSCN0412	KAR63	KAR63 - RAMP STAIRCASE - 4 STEP - NO INFILL
KARSCN0512	KAR64	KAR64 - RAMP STAIRCASE - 5 STEP - NO INFILL
KARSCV0212	KAR65	KAR65 - RAMP STAIRCASE - 2 STEP - C/W VBI
KARSCV0312	KAR66	KAR66 - RAMP STAIRCASE - 3 STEP - C/W VBI
KARSCV0412	KAR67	KAR67 - RAMP STAIRCASE - 4 STEP - C/W VBI
KARSCV0512	KAR68	KAR68 - RAMP STAIRCASE - 5 STEP - C/W VBI

1. Transition Module

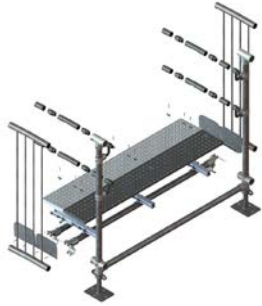

2. Angled Intermediate



3. Corner

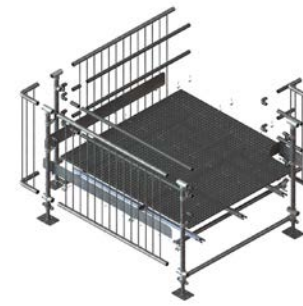

4. Flat End

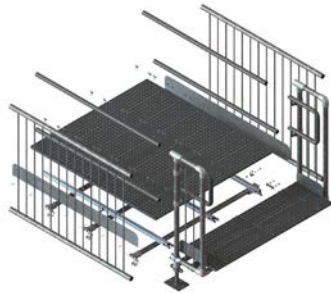

5. End

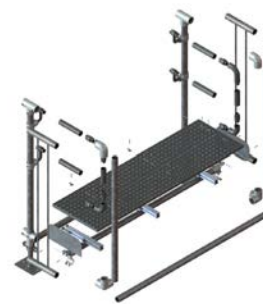

6. Flat Intermediate

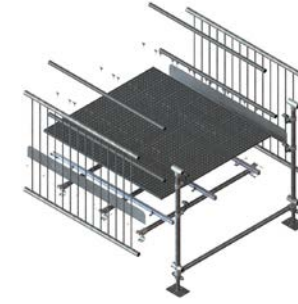

7. Start



8. Stairs



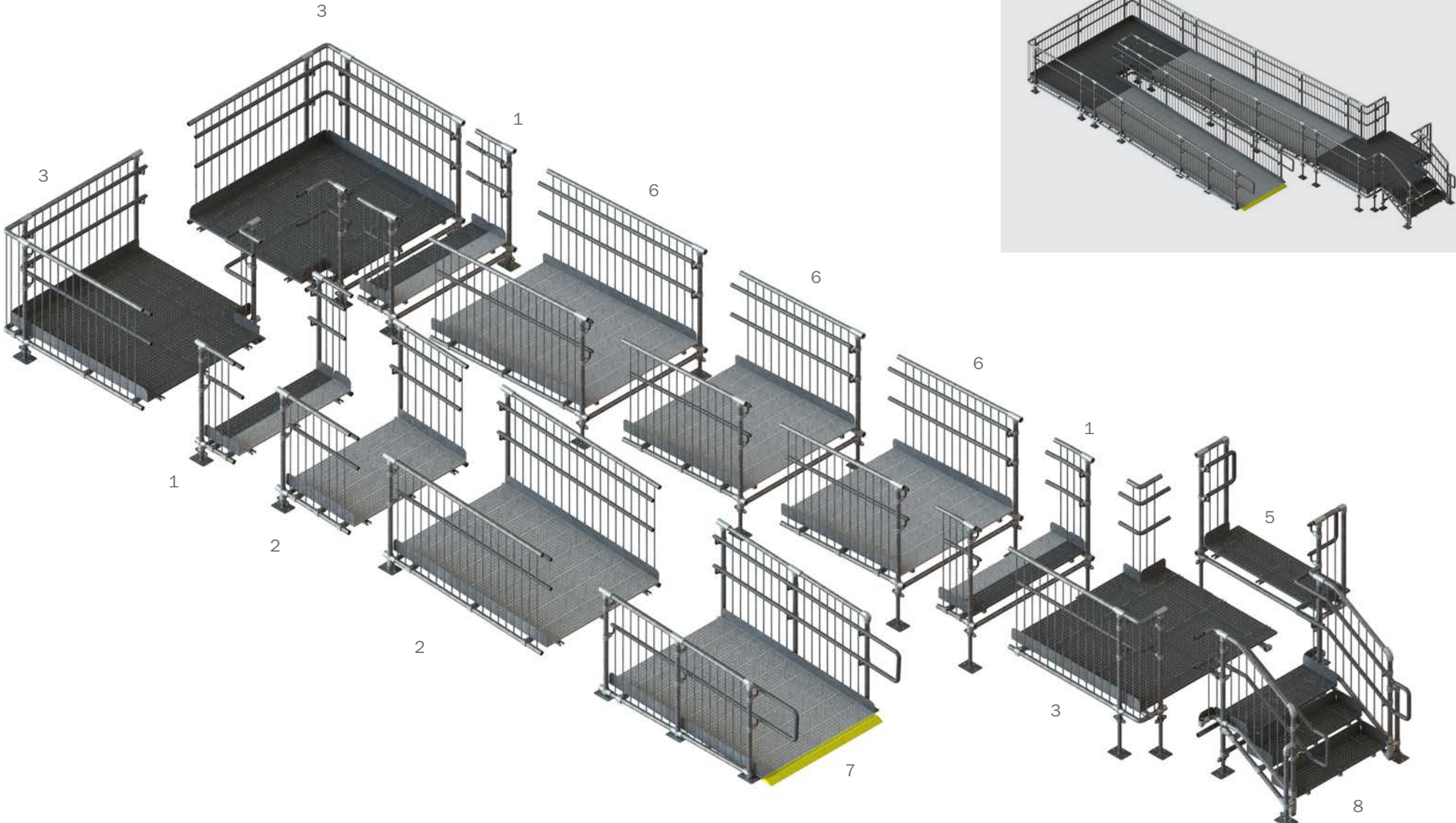

## 5. ASSEMBLY AND INSTALLATION

During installation at least two people should be working in tandem, and be mindful of risks associated with the location; for example, in a school environment or public building care must be taken to ensure the safety of operatives and members of the general public is maintained at all times in line with the buildings.

### 5.1 Tools list

- Ratchet
- Hex key socket screw sized 5/16" AF
- Torque wrench 10-60Nm
- Electric/battery drill
- Electric/battery impact driver
- Selection of drill bits – including 8.5mm diameter bit
- Tape measure
- Line and level
- Full metric socket set
- Full set metric spanners
- Full set of metric allen keys
- Full set of imperial allen keys
- Copper/rubber mallet
- Rags and cleaning fluid

### 5.2 Checking the ramp system's components

**DANGER TO LIFE!** 

If some of the parts listed in the parts list or on the delivery note are missing or damaged, then you must replace them with original parts. Contact the manufacturer to obtain these.

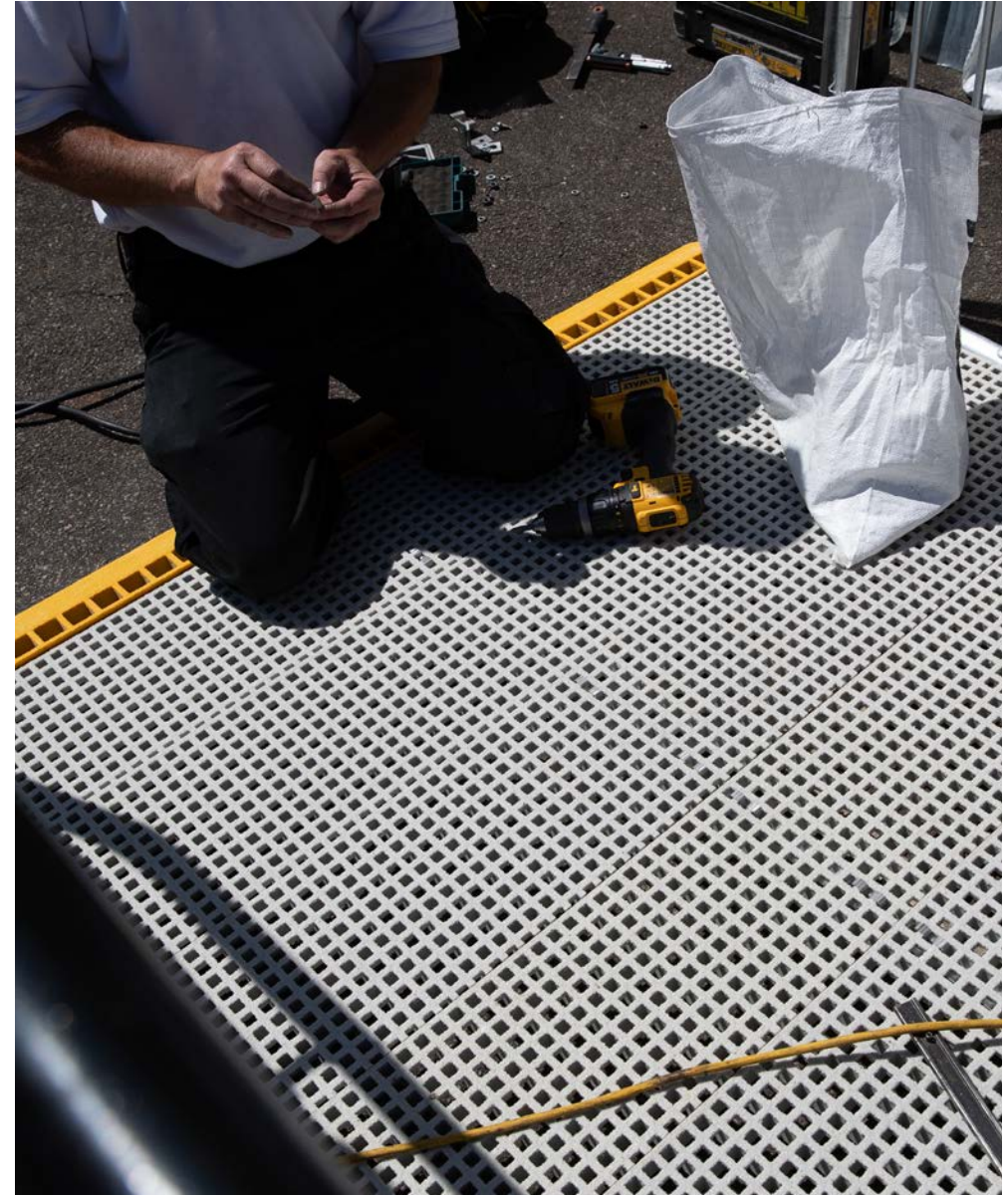

**Note:** A complete list of all parts and details on the total weight of the ramp system are provided with the delivery. The load-bearing capacity of the substrate must be equal to or exceed the capacity specified.

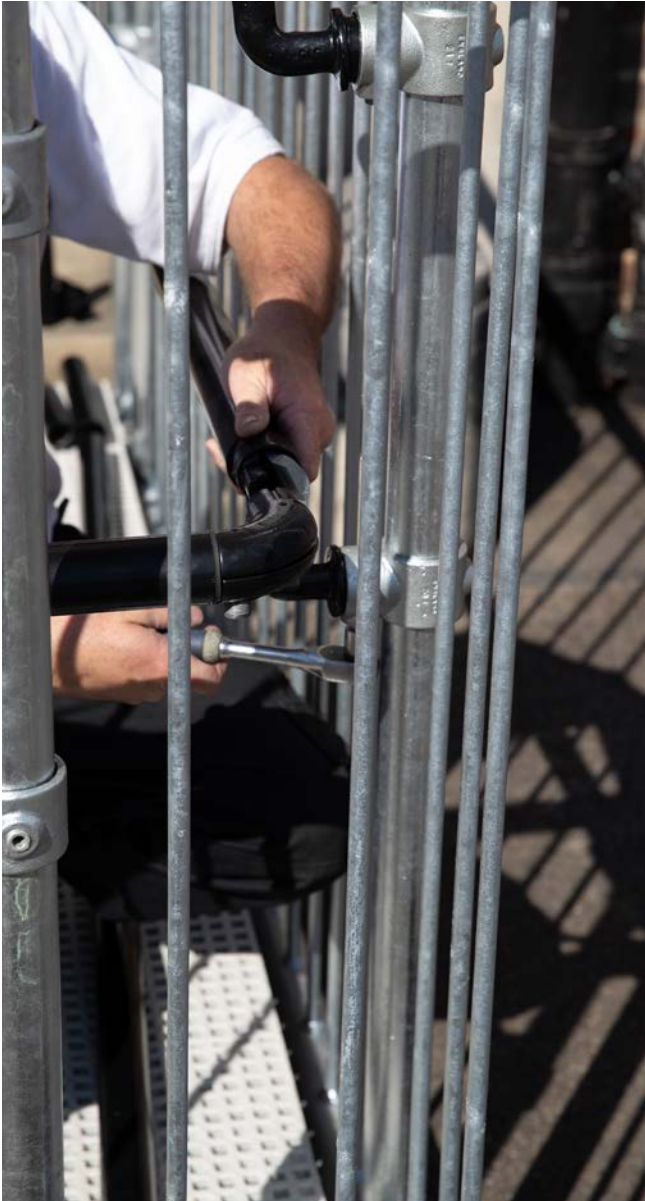

## 5.1 ASSEMBLING THE RAMP END MODULE

### Step 1

#### Assembling the rear frame

The installation of the ramp starts with the installer assembling the end module, at the target install position where access is required. Locate and identify the correct uprights (see module drawing pack for more info), insert the legs into the tube ensuring the collar is correctly seated. Add the horizontal brace to the left hand upright, tighten grubscrew in fittings to hand tight (also known as 'hold point') to locate tube, and add right hand upright, again with a light tightening of the grubscrew.

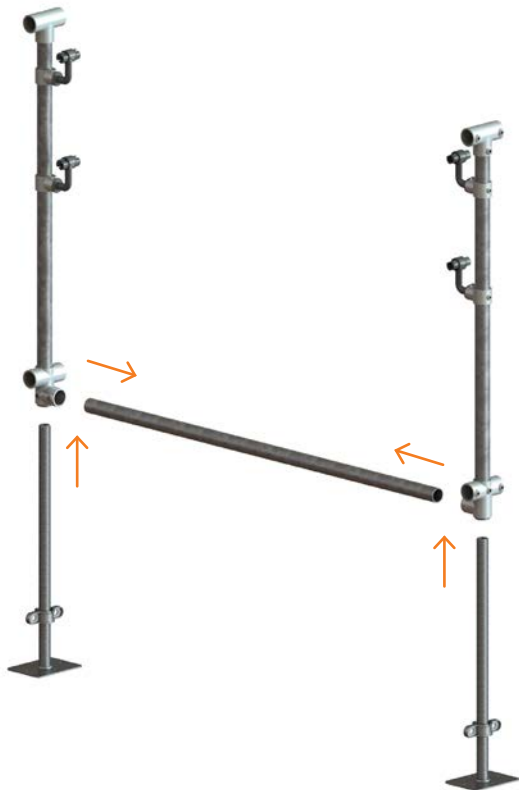

### Step 2

#### Repeat step 1 - Front frame assembly

Repeat step two entirely, to create the front frame subassembly.



**Note:** Imagery used is of VBI construction, all steps are the same for the tube-only variant.

## Step 3

### Inserting VBI or tube to create unit

Identify module being built, either VBI (Vertical Bar Infill) side panel equipped, or tube-only. Locate correct length panel or galvanised tubes, locate powder coated handrails.

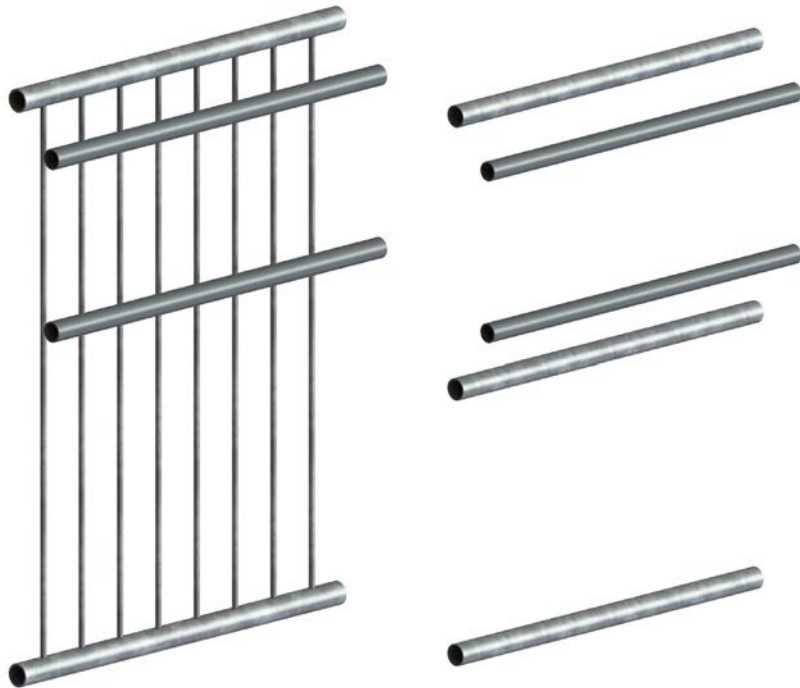

## Step 4

### Inserting VBI side panel or guardrail tube.

Starting on the lefthand side, insert the VBI panel or guardrail tube into the rear frame, add powdercoated handrails, tighten fittings to hold point. Repeat for right hand side, then bring front frame into position, ensuring to locate all tubes in correct socket positions. Tighten fittings to hold point.



### 5.1 ASSEMBLING THE RAMP END MODULE

#### Step 5

##### Part build verification

At this point, verify that all tubes are present and correct, legs are all in place and at the correct height, and all fittings are in the 'hold point' position.



#### Step 6

##### Part assembly of VBI or guardrail tube end unit

Identify and locate correct size VBI panel or guardrails tube for the end bay. Starting on the lefthand side, insert the VBI panel or guardrail tube into the building end of the rear frame fittings, add powdercoated handrails, tighten fittings to hold point. Repeat for right hand side, tighten fittings to hold point.





**Note:** Imagery used is of VBI construction, all steps are the same for the tube-only variant.

## Step 7

### Part assembly of VBI or guardrail tube end unit.

Locate lower rail, insert uprights into lower sockets, tighten to hold point to form U shaped sub assembly (Fig. 8a) Taking care to locate all tubes into fittings sockets, add U frame assembly to existing end unit, complete with elbows. Add powdercoated D return to end unit, tighten all fittings to hold point.

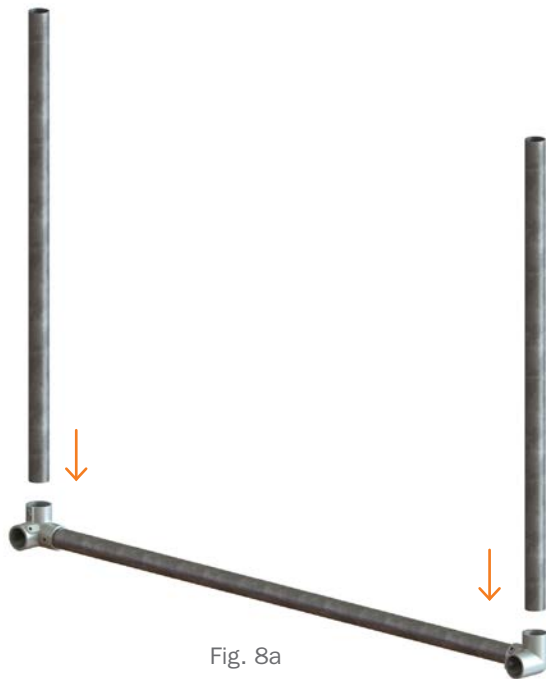

### 5.1 ASSEMBLING THE RAMP END MODULE

#### Step 8

##### Adding horizontal tread support rails

Locate tread support rails, ensuring A10 fittings are open, and locking pins are present and accessible. Using module drawings to identify location, place all horizontals in place, close A10 fittings, add dowel to close, tighten grub screws to hold point.

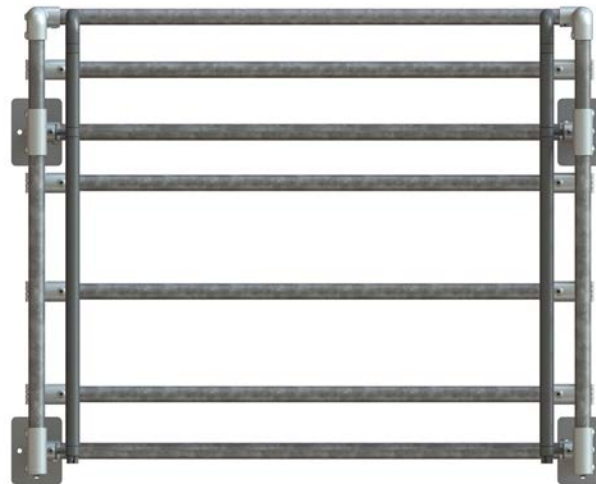

**Note:** Imagery used is of VBI construction, all steps are the same for the tube-only variant.

## Step 9

### Adding tread support extrusions

Locate tread support extrusions, lay out on part built module as shown in drawing pack. Using Tek screws, locate the angle bracket to the cross tube (see Fig. 10b). Repeat for all brackets. Where extrusions need to be joined, they should be used and assembled as per Fig. 10c.

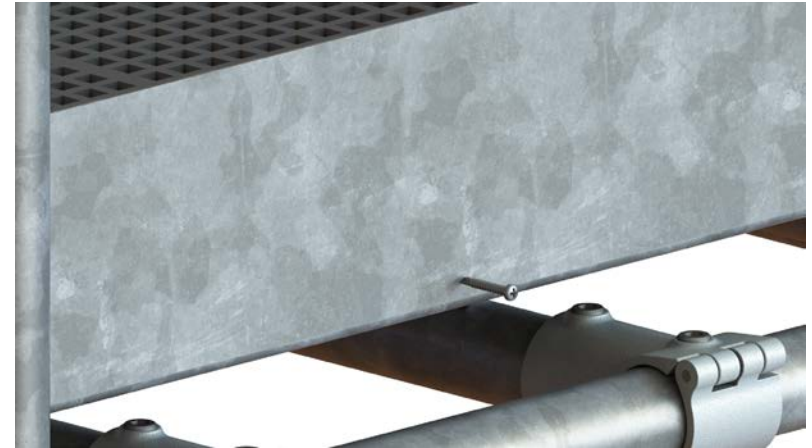
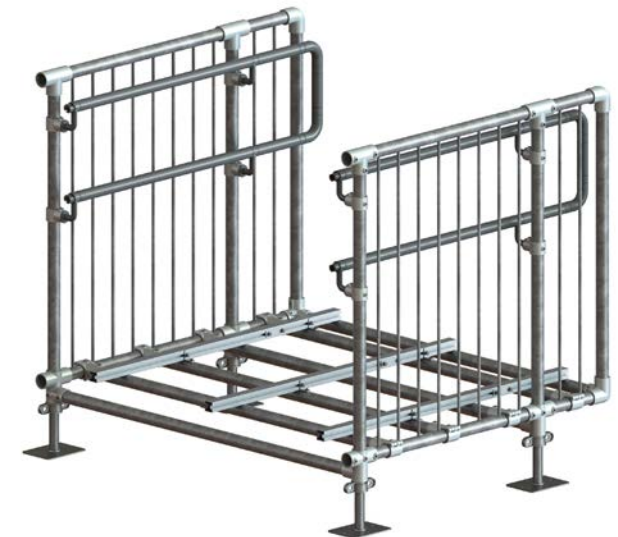
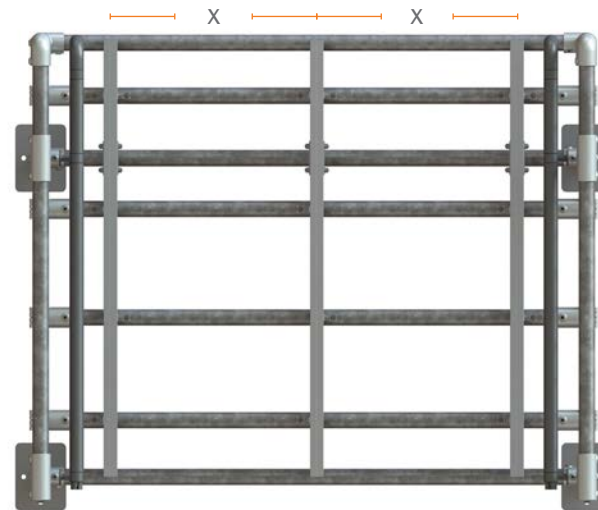

Fig. 10b



Fig. 10c



## 5.1 ASSEMBLING THE RAMP END MODULE

### Step 10

#### Adding Treads

Locate treads, lay out first two treads, starting at the building end, ensuring tread finishes flush with the end of the extrusion. Using the supplied U clips and self tapping screws, use 6 off (2 per extrusion), equally spaced (see Fig. 11a).

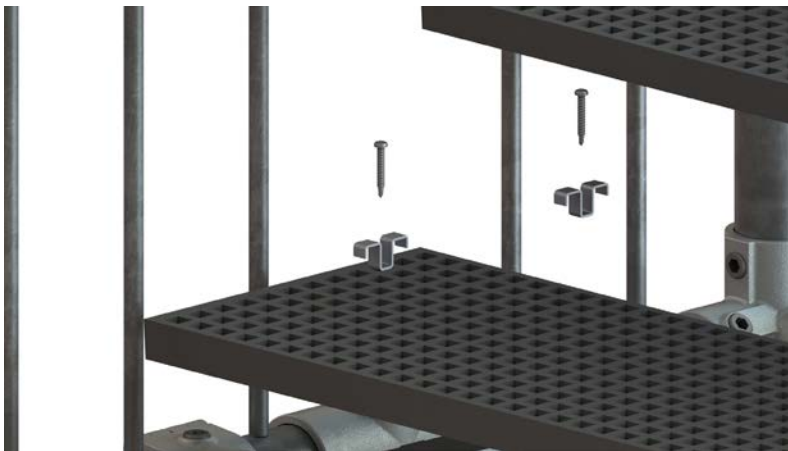

Fig. 11a



**Note:** Imagery used is of VBI construction, all steps are the same for the tube-only variant.

## Step 11

### Adding remaining treads and toeboards.

Add remaining treads, secure as in step 11. Add toeboards to left and right of treads, secure through face of the toeboard using tek screw into the tread.

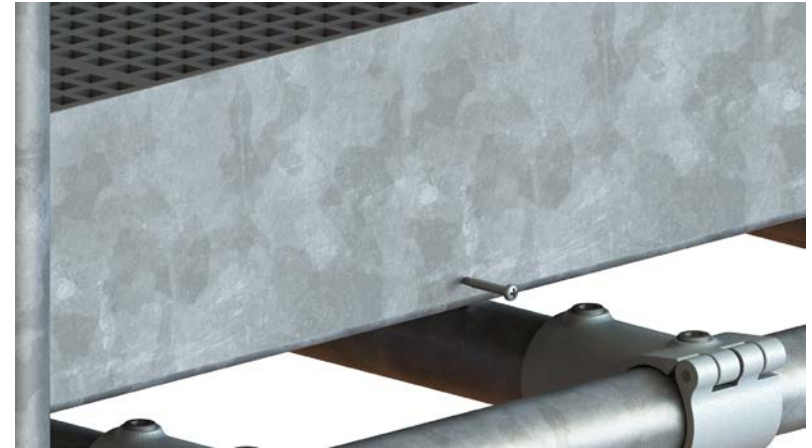

## 5.1 ASSEMBLING THE RAMP END MODULE

### Step 12

#### Final verification of build

Once all components are assembled as per drawing, ensure all walking surfaces are level or at the required angle, fixed, and that all grubscrews are tightened to 39Nm.

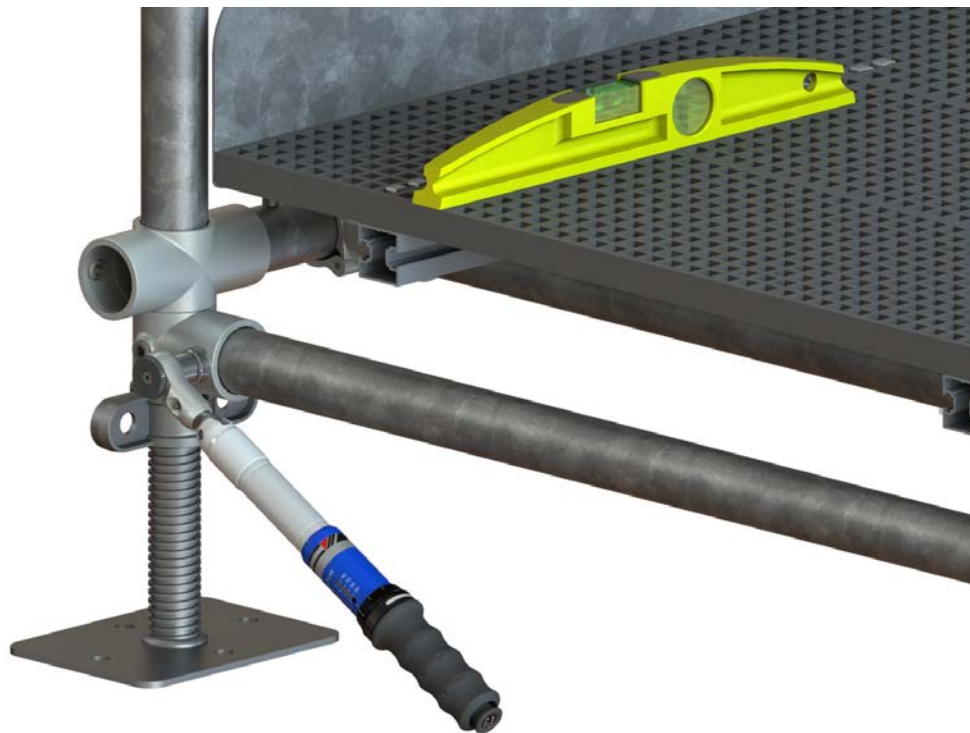

### Step 13

#### Final verification of build

Ensure end unit is situated at the install site correctly, that the level is correct, and unhindered access can be made into the building with a seamless transition from the ramp over the threshold. Some adjustment may be required to enable this. See step 14.

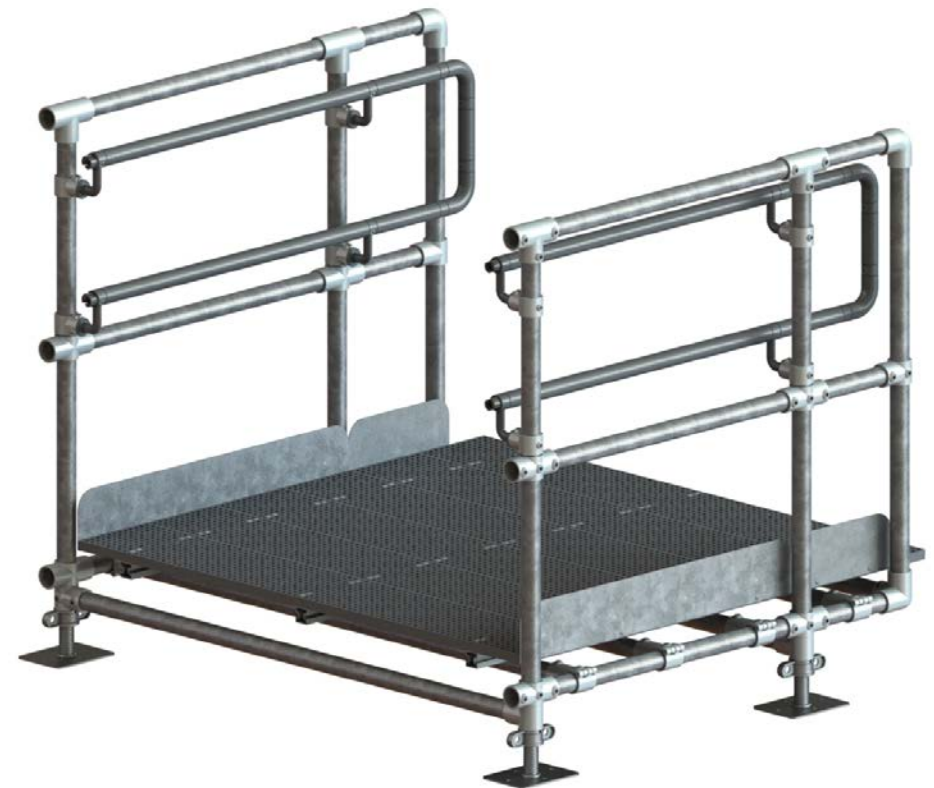

**Note:** Imagery used is of VBI construction, all steps are the same for the tube-only variant.

## Step 14

### Adapting to site condition.

It may be necessary to adapt the end bay to suit the required transition from building, to this end the tread can be cut to suit the opening present, guardrail ends including VBI panels can be cut down, as can handrails. it is preferential for the responsible design engineer to have accounted for this in the final module adaptation ahead of install.

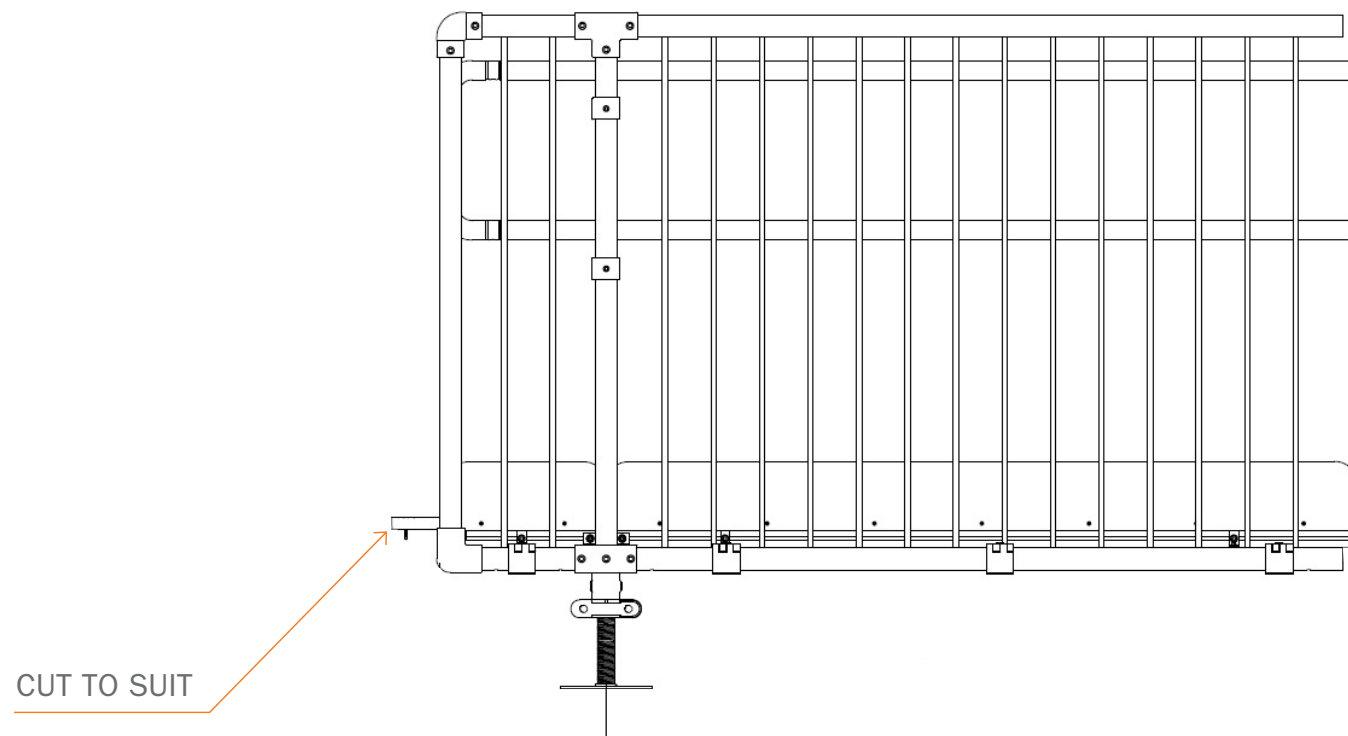

## 5.2 ASSEMBLING THE FLAT RAMP MODULE

### Step 1

#### Inserting VBI or tube to create unit

Identify next module being built, either VBI (Vertical Bar Infill) side panel equipped, or tube-only. Locate correct length panel or galvanised tubes, locate powder coated handrails.

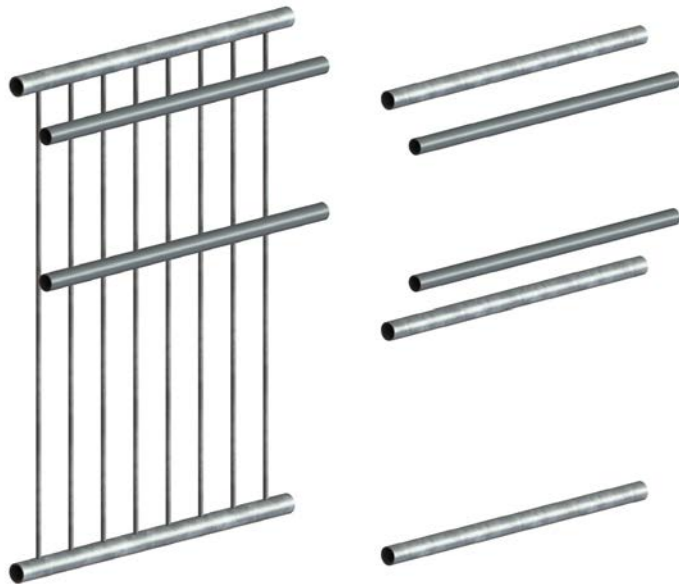

### Step 2

#### Inserting VBI side panel or guardrail tube

Starting on the lefthand side, insert the VBI panel or guardrail tube into the previously built module, add powdercoated handrails, tighten fittings to hold point. Repeat for right hand side.





**Note:** Imagery used is of VBI construction, all steps are the same for the tube-only variant, in addition, for all module additions, the proceeding module is always assembled onto the existing module.

## Step 3

### Assembling the front frame

Locate and identify the correct uprights (see module drawing pack for more info), insert the legs into the tube ensuring the collar is correctly seated. Add the horizontal brace to the left hand upright, tighten grubscrew in fittings to hand tight (also known as 'hold point') to locate tube, and add right hand upright, again with a light tightening of the grubscrew.

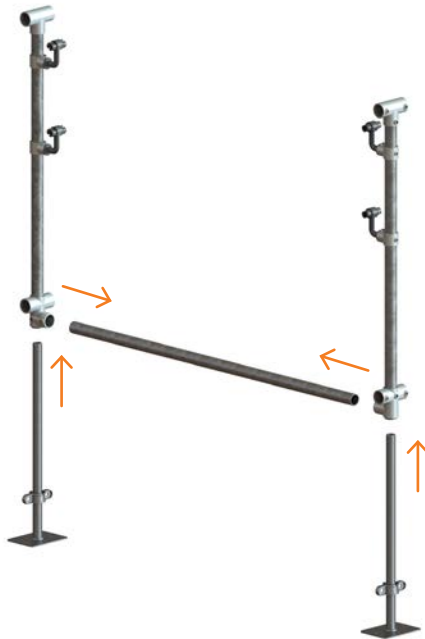

## Step 4

### Adding the front frame and part build verification

Bring front frame into position, ensuring to locate all tubes in correct socket positions. Tighten fittings to hold point. Adjust leg heights to ensure ramp is level, checking with a spirit level. At this point, verify that all tubes are present and correct, legs are all in place and at the correct height, and all fittings are in the 'hold point' position.

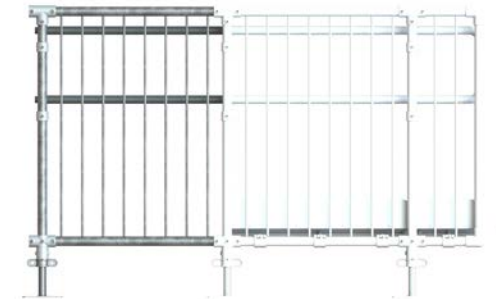

### 5.2 ASSEMBLING THE FLAT RAMP MODULE

#### Step 5

##### Adding horizontal tread support rails

Locate tread support rails, ensuring A10 fittings are open, and locking pins are present and accessible. Using module drawings to identify location, place all horizontals in place, close A10 fittings, add dowel to close, tighten grub screws to hold point.

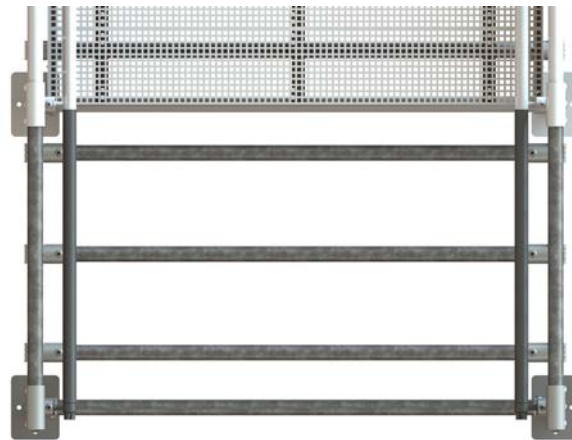

**Note:** Imagery used is of VBI construction, all steps are the same for the tube-only variant, in addition, for all module additions, the proceeding module is always assembled onto the existing module.

## Step 6

### Adding tread support extrusions

Locate tread support extrusions, lay out on part built module as shown in drawing pack. Using Tek screws, locate the angle bracket to the cross tube (see Fig. 10b). Repeat for all brackets. Where extrusions need to be joined, should be assembled as per Fig. 10c.

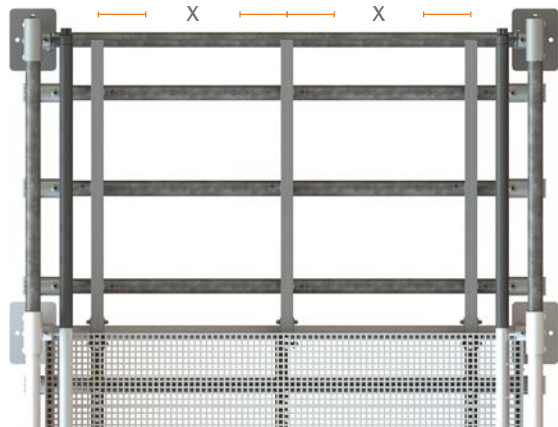

Fig. 10b

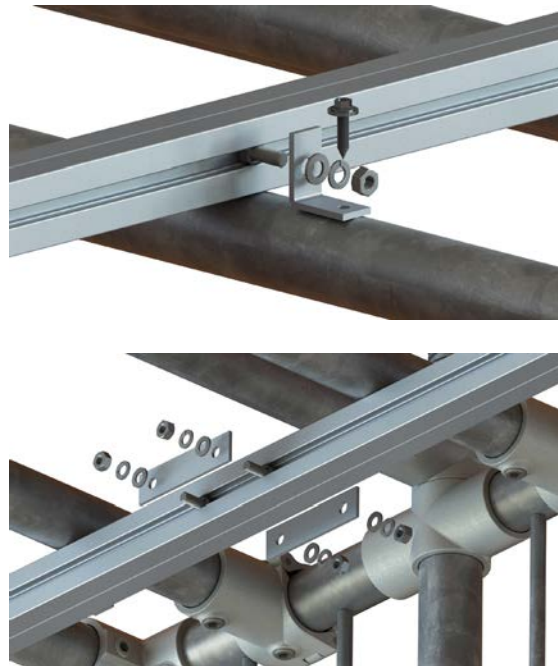

Fig. 10c



### 5.2 ASSEMBLING THE FLAT RAMP MODULE

#### Step 7

##### Adding treads

Locate treads, lay out first two treads, starting at the built end, ensuring tread finishes flush with the end of the extrusion. Using the supplied U clips and self tapping screws, use 6 off (2 per extrusion, equally spaced see Fig. 11a).

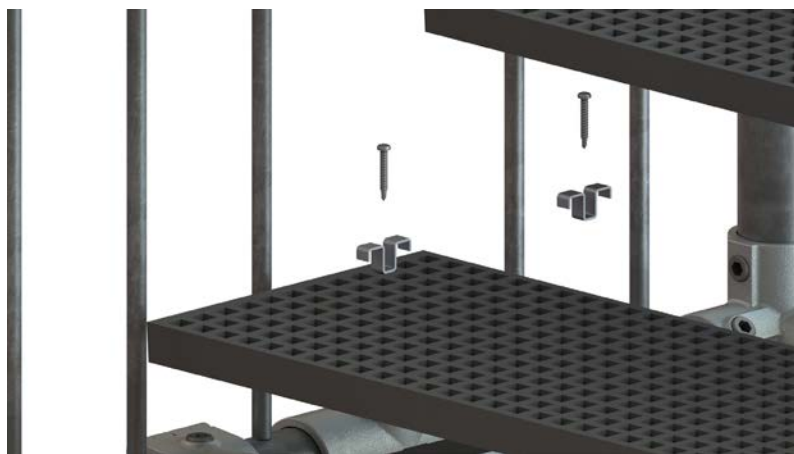

Fig. 11a



**Note:** Imagery used is of VBI construction, all steps are the same for the tube-only variant, in addition, for all module additions, the proceeding module is always assembled onto the existing module.

## Step 8

### Adding remaining treads and toeboards

Add remaining treads, secure as in step 11 on page 29. Add toeboards to left and right of treads, secure through face of the toeboard using tek screw into the tread.



### 5.3 ASSEMBLING THE CORNER RAMP MODULE

#### Step 1

##### Inserting VBI or tube to create unit

Identify module being built, either VBI (Vertical Bar Infill) side panel equipped, or tube-only. Locate correct length panel or galvanised tubes, locate powder coated handrails.

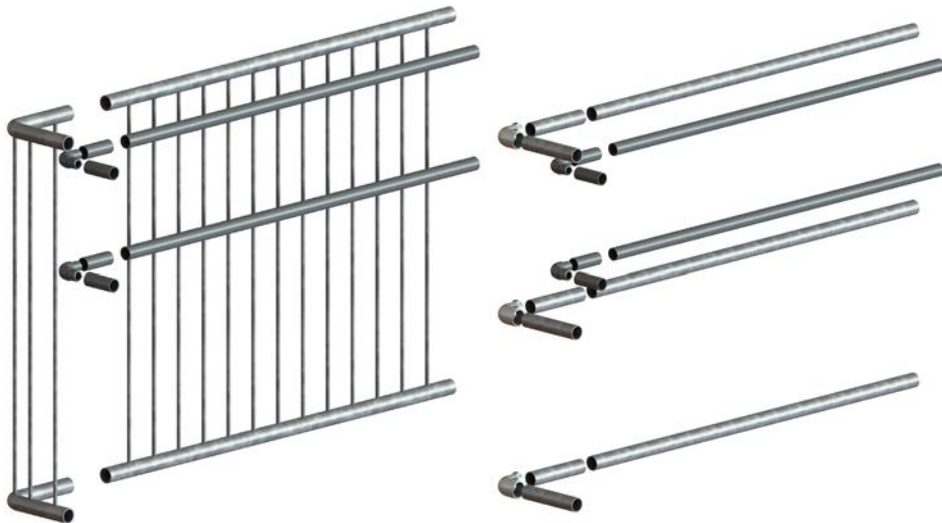

#### Step 2

##### Inserting VBI side panel or guardrail tube

Starting on the lefthand side, insert the VBI panel or guardrail tube into the previously built module, add powdercoated handrails, tighten fittings to hold point.



**Note:** Imagery used is of VBI construction, all steps are the same for the tube-only variant, in addition, for all module additions, the proceeding module is always assembled onto the existing module.

## Step 3

### Adding the corner upright

Select the corner upright (see module drawing pack for more info), bring into position, ensuring to locate all tubes in correct socket positions. Tighten fittings to hold point. Adjust leg height to ensure ramp is at the correct angle. At this point, verify that all tubes are present and correct, legs are all in place and at the correct height, and all fittings are in the 'hold point' position.



### 5.3 ASSEMBLING THE CORNER RAMP MODULE

#### Step 4

##### Forming the corner

Select the corner VBI panel (or formed tube where not used), insert tubes into corner upright sockets. Add formed powdercoated handrail corners. Tighten fittings to hold point.





**Note:** Imagery used is of VBI construction, all steps are the same for the tube-only variant, in addition, for all module additions, the proceeding module is always assembled onto the existing module.

## Step 5

### Adding the 2nd corner upright

Select the corner upright (see module drawing pack for more info) bring into position, ensuring to locate all tubes in correct socket positions. Tighten fittings to hold point. Adjust leg height to ensure ramp is at the correct angle. At this point, verify that all tubes are present and correct, legs are all in place and at the correct height, and all fittings are in the 'hold point' position.



## 5.3 ASSEMBLING THE CORNER RAMP MODULE

### Step 6

#### Inserting VBI side panel or guardrail tube

Starting on the lefthand side, insert the VBI panel or guardrail tube into the previously built module, add powdercoated handrails, tighten fittings to hold point to create the external corner (Fig. 6a). Locate the smaller internal corner VBI panel or formed tube, insert the VBI panel or tube into the previously built module, add powdercoated handrails, tighten fittings to hold point to create the internal corner (Fig. 6b).



Fig. 6a



Fig. 6b

**Note:** Imagery used is of VBI construction, all steps are the same for the tube-only variant, in addition, for all module additions, the proceeding module is always assembled onto the existing module.

## Step 7

### Assembling the end frame

Locate and identify the correct uprights (see drawing pack for more info), insert the legs into the tube ensuring the collar is correctly seated. Add the horizontal brace to the left hand upright, tighten grubscrew in fittings to hand tight (also known as 'hold point') to locate tube, and add right hand upright, again with a light tightening of the grubscrew.

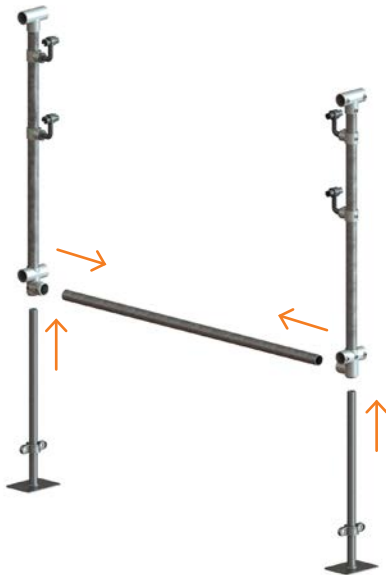

## Step 8

### Adding the end frame and part build verification

Bring end frame into position, ensuring to locate all tubes in correct socket positions. Tighten fittings to hold point. Adjust leg heights to ensure ramp is at the correct angle. At this point, verify that all tubes are present and correct, legs are all in place and at the correct height, and all fittings are in the 'hold point' position.

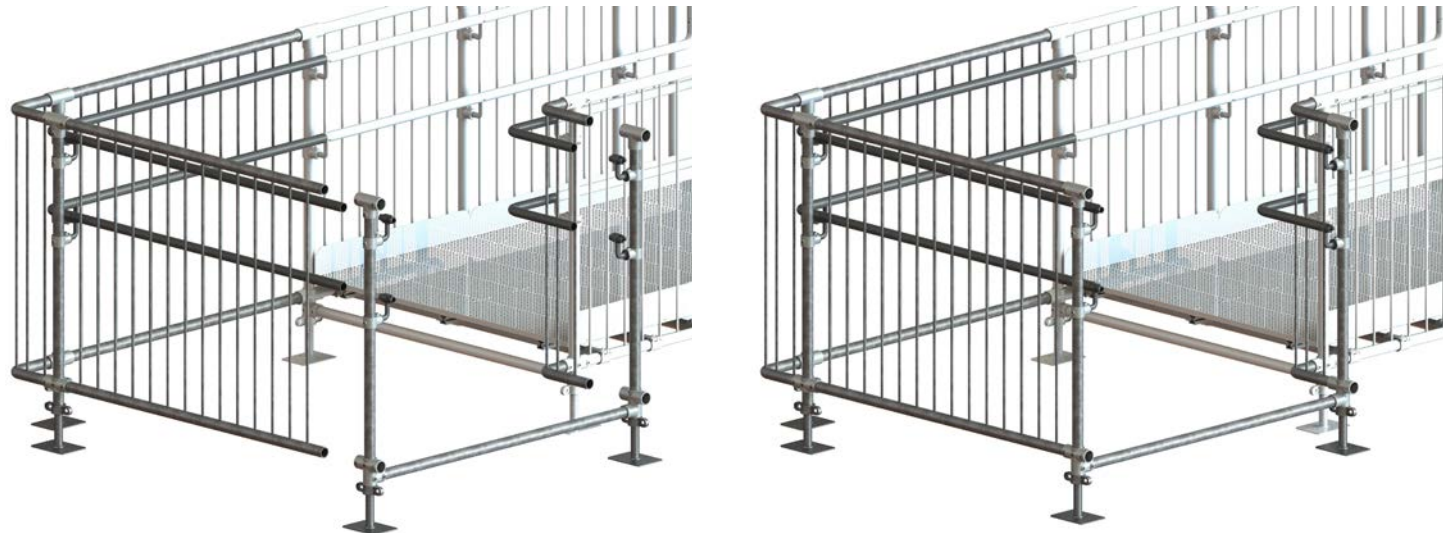

### 5.3 ASSEMBLING THE CORNER RAMP MODULE

#### Step 9

##### Adding horizontal tread support rails

Locate tread support rails, ensuring A10 fittings are open, and locking pins are present and accessible. Using module drawings to identify location, place all horizontals in place, close A10 fittings, add dowel to close, tighten grub screws to hold point.

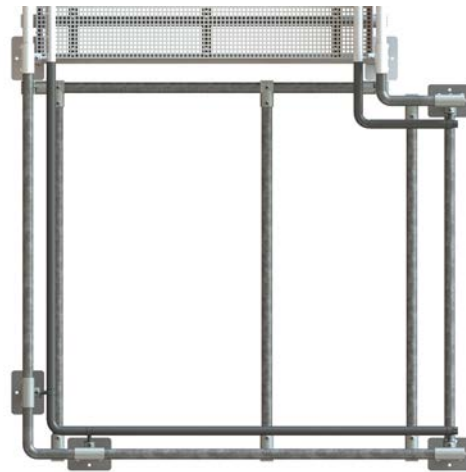

**Note:** Imagery used is of VBI construction, all steps are the same for the tube-only variant, in addition, for all module additions, the proceeding module is always assembled onto the existing module.

## Step 10

Locate tread support extrusions, lay out on part built module as shown in drawing pack. Using Tek screws, locate the angle bracket to the cross tube (see Fig. 10b). Repeat for all brackets. Where extrusions need to be joined, should be assembled as per Fig. 10c.

**Where extrusions intersect, connect together with angle brackets as shown in Fig. 10.d**

Fig. 6a

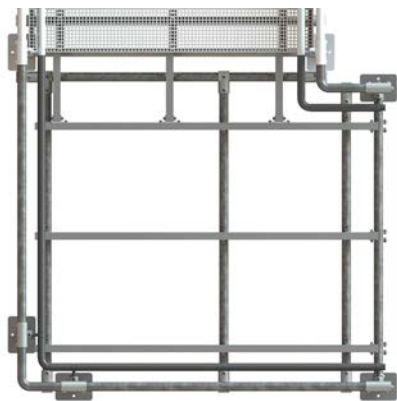

Fig. 6c

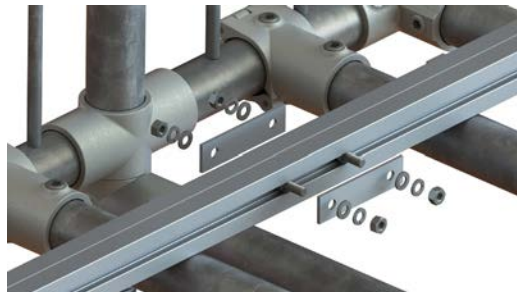

Fig. 6b

Fig. 6d

### 5.3 ASSEMBLING THE CORNER RAMP MODULE

#### Step 11

##### Adding treads

Locate treads, lay out first two treads, starting perpendicular to the built end, ensuring tread finishes flush with the end of the extrusion. Using the supplied U clips and self tapping screws, use 6 off (2 per extrusion, equally spaced see Fig. 11a).

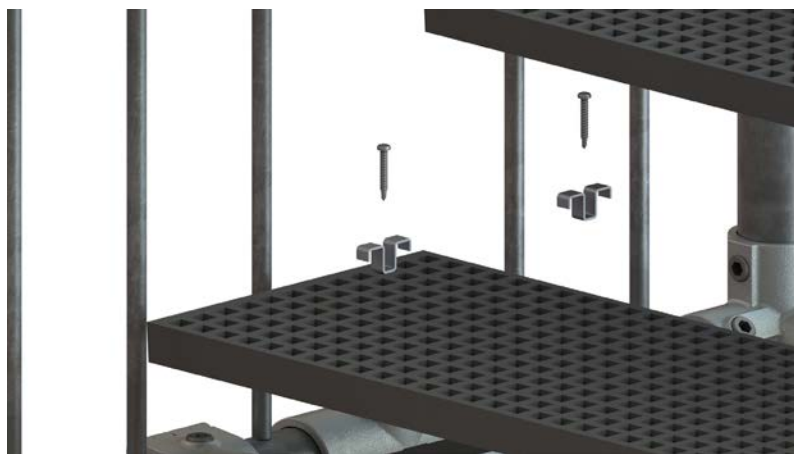

Fig. 11a



**Note:** Imagery used is of VBI construction, all steps are the same for the tube-only variant, in addition, for all module additions, the proceeding module is always assembled onto the existing module.

## Step 12

### Adding remaining treads and toeboards

Add remaining treads, secure as in step 11. Add toeboards to left and right of treads, secure through face of the toeboard using tek screw into the tread.

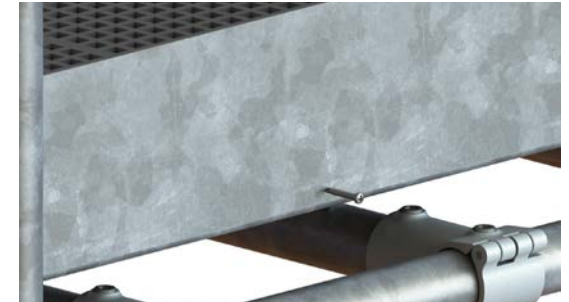

## 5.4 ASSEMBLING THE TRANSITION MODULE

### Step 1

#### Inserting VBI or tube to create unit

Identify module being built, either VBI (Vertical Bar Infill) side panel equipped, or tube-only. Locate correct length panel or galvanised tubes, locate powder coated handrails.

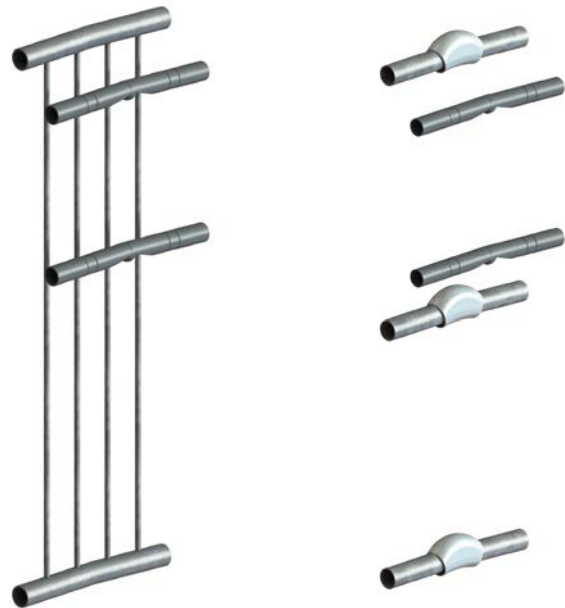

### Step 2

#### Inserting VBI side panel or guardrail tube

Starting on the lefthand side, insert the VBI panel or guardrail tube into the previously built module, add powdercoated handrails, tighten fittings to hold point. Repeat for right hand side.





**Note:** Imagery used is of VBI construction, all steps are the same for the tube-only variant, in addition, for all module additions, the proceeding module is always assembled onto the existing module.

## Step 3

### Assembling the front frame

Locate and identify the correct uprights (see module drawing pack for more info), insert the legs into the tube ensuring the collar is correctly seated. Add the horizontal brace to the left hand upright, tighten grubscrew in fittings to hand tight (also known as 'hold point') to locate tube, and add right hand upright, again with a light tightening of the grubscrew.

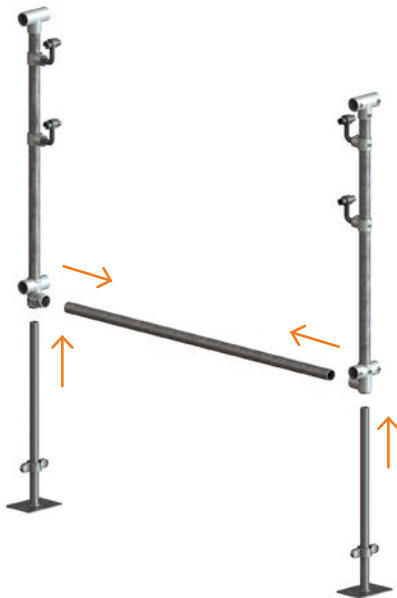

## Step 4

### Adding the front frame and part build verification

Bring front frame into position, ensuring to locate all tubes in correct socket positions. Tighten fittings to hold point. Adjust leg heights to ensure ramp is at the correct angle. At this point, verify that all tubes are present and correct, legs are all in place and at the correct height, and all fittings are in the 'hold point' position.



### 5.4 ASSEMBLING THE TRANSITION MODULE

#### Step 5

##### Adding horizontal tread support rails

Locate tread support rails, ensuring A10 fittings are open, and locking pins are present and accessible. Using module drawings to identify location, place all horizontals in place, close A10 fittings, add dowel to close, tighten grub screws to hold point.

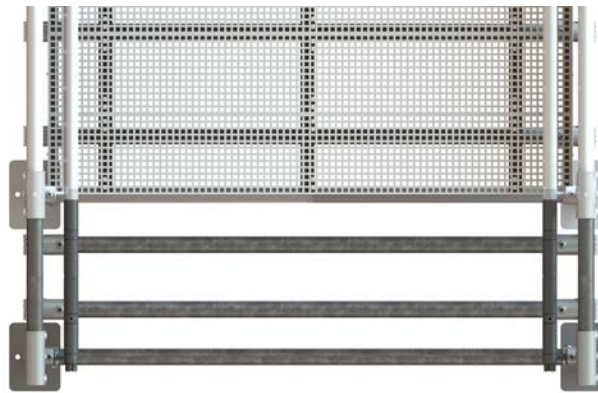

**Note:** Imagery used is of VBI construction, all steps are the same for the tube-only variant, in addition, for all module additions, the proceeding module is always assembled onto the existing module.

## Step 6

### Adding tread support extrusions

Locate tread support extrusions, lay out on part built module as shown in drawing pack. Using Tek screws, locate the angle bracket to the cross tube (see Fig. 10b). Repeat for all brackets. Where extrusions need to be joined, should be assembled as per Fig. 10c.

Fig. 10b

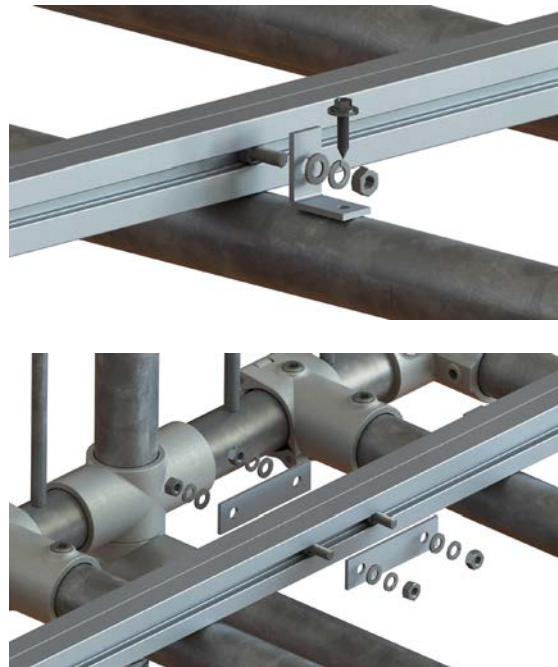

Fig. 10c



### 5.4 ASSEMBLING THE TRANSITION MODULE

#### Step 7

##### Adding treads

Locate treads, lay out first two treads, starting at the built end, ensuring tread finishes flush with the end of the extrusion. Using the supplied U clips and self tapping screws, use 6 off (2 per extrusion, equally spaced see Fig. 11a).

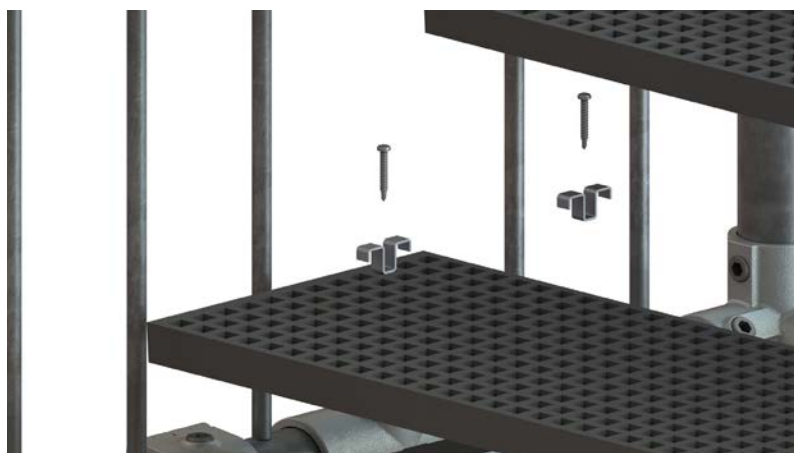

Fig. 11a



**Note:** Imagery used is of VBI construction, all steps are the same for the tube-only variant, in addition, for all module additions, the proceeding module is always assembled onto the existing module.

## Step 8

### Adding remaining treads and toeboards

Add remaining treads, secure as in step 11. Add toeboards to left and right of treads, secure through face of the toeboard using tek screw into the tread.

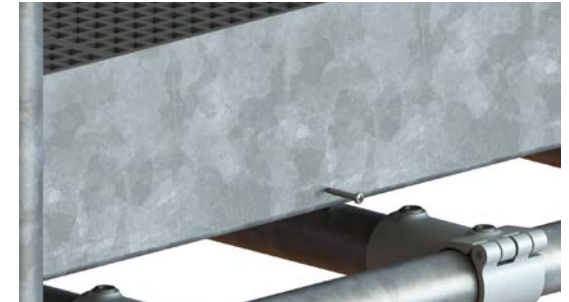

## 5.5 ASSEMBLING THE 3° RAMP MODULE

### Step 1

#### Inserting VBI or tube to create unit

Identify module being built, either VBI (Vertical Bar Infill) side panel equipped, or tube-only. Locate correct length panel or galvanised tubes, locate powder coated handrails.

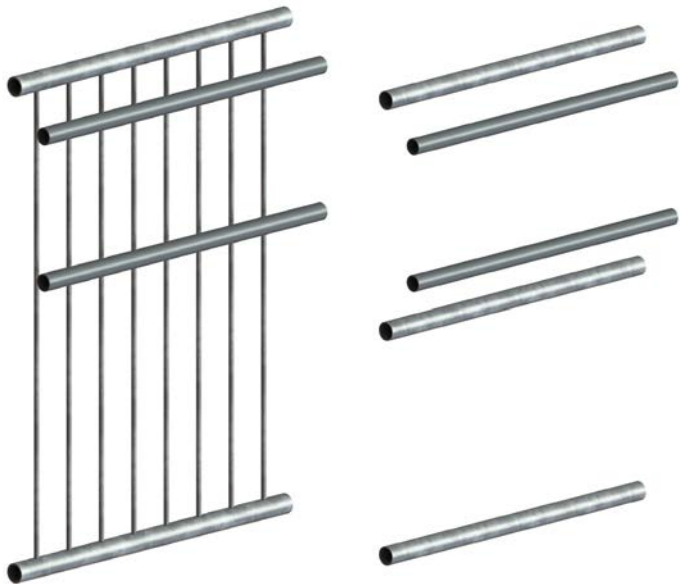

### Step 2

#### Inserting VBI side panel or guardrail tube

Starting on the lefthand side, insert the VBI panel or guardrail tube into the previously built module, add powdercoated handrails, tighten fittings to hold point. Repeat for right hand side.



**Note:** Imagery used is of VBI construction, all steps are the same for the tube-only variant, in addition, for all module additions, the proceeding module is always assembled onto the existing module.

## Step 3

### Assembling the front frame

Locate and identify the correct uprights (see module drawing pack for more info) insert the legs into the tube ensuring the collar is correctly seated. Add the horizontal brace to the left hand upright, tighten grubscrew in fittings to hand tight (also known as 'hold point') to locate tube, and add right hand upright, again with a light tightening of the grubscrew.

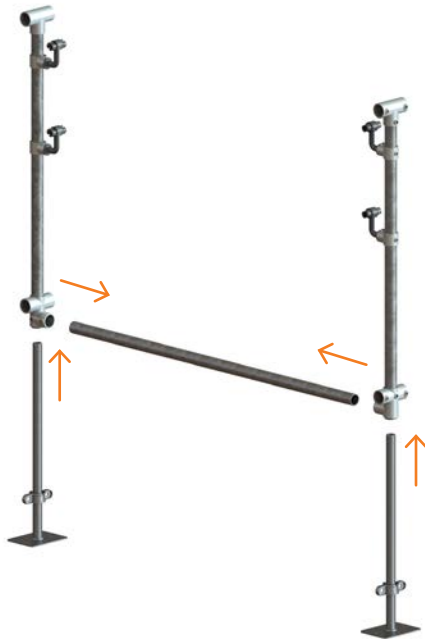

## Step 4

### Adding the front frame and part build verification

Bring front frame into position, ensuring to locate all tubes in correct socket positions. Tighten fittings to hold point. Adjust leg heights to ensure ramp is at the correct 3° angle. At this point, verify that all tubes are present and correct, legs are all in place and at the correct height, and all fittings are in the 'hold point' position.



### 5.5 ASSEMBLING THE 3° RAMP MODULE

#### Step 5

##### Adding horizontal tread support rails

Locate tread support rails, ensuring A10 fittings are open, and locking pins are present and accessible. Using module drawings to identify location, place all horizontals in place, close A10 fittings, add dowel to close, tighten grub screws to hold point.

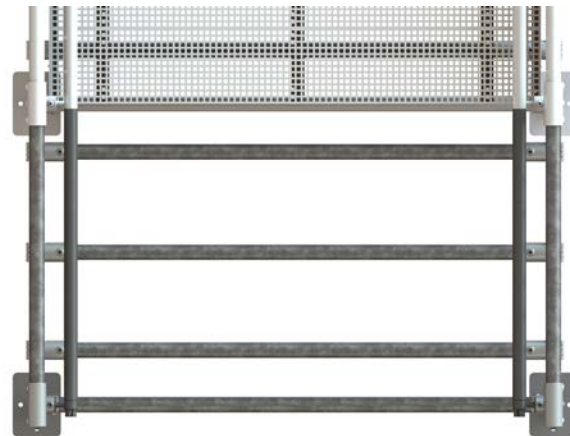



**Note:** Imagery used is of VBI construction, all steps are the same for the tube-only variant, in addition, for all module additions, the proceeding module is always assembled onto the existing module.

## Step 6

### Adding tread support extrusions

Locate tread support extrusions, lay out on part built module as shown in drawing pack. Using Tek screws, locate the angle bracket to the cross tube (see Fig. 10b). Repeat for all brackets. Where extrusions need to be joined, the part WW1003030 should be used and assembled as per Fig. 10c.

Fig. 10b

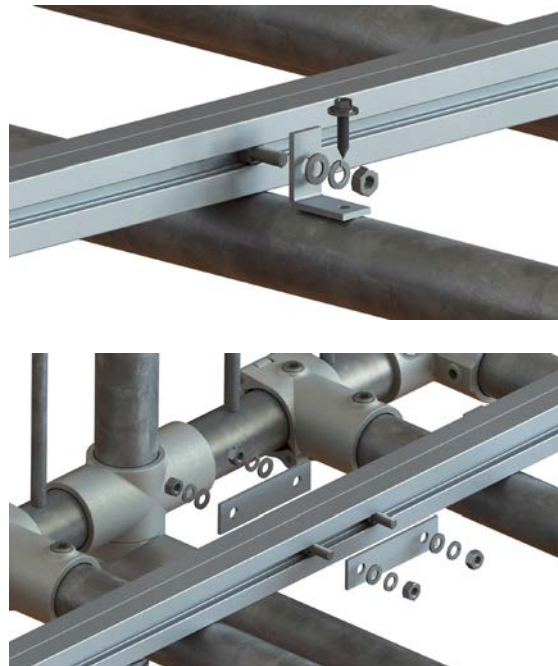
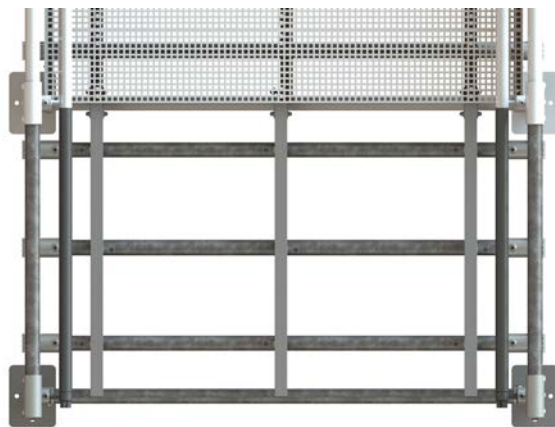

Fig. 10c



### 5.5 ASSEMBLING THE 3° RAMP MODULE

#### Step 7

##### Adding treads

Locate treads, lay out first two treads, starting at the built end, ensuring tread finishes flush with the end of the extrusion. Using the supplied U clips and self tapping screws, use 6 off (2 per extrusion, equally spaced see Fig. 11a).

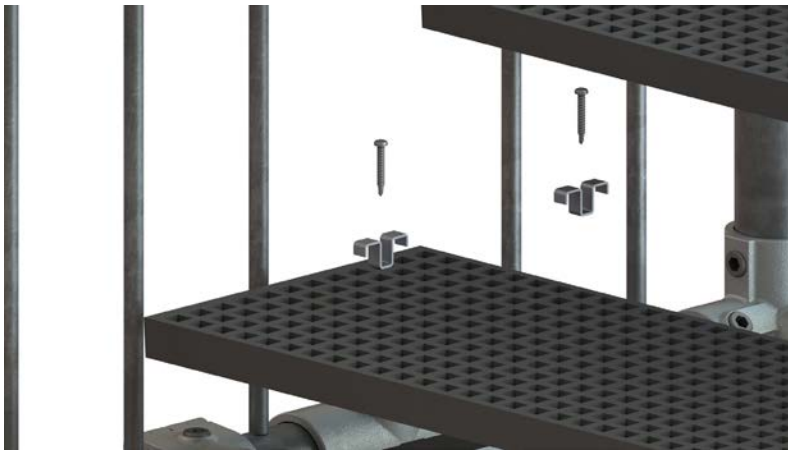

Fig. 11a



**Note:** Imagery used is of VBI construction, all steps are the same for the tube-only variant, in addition, for all module additions, the proceeding module is always assembled onto the existing module.

## Step 8

### Adding remaining treads and toeboards

Add remaining treads, secure as in step 11 on page 29. Add toeboards to left and right of treads, secure through face of the toeboard using tek screw into the tread.

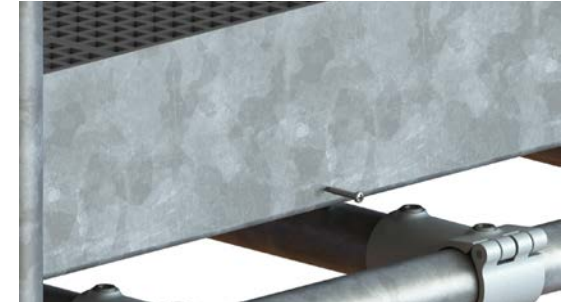

### 5.6 ASSEMBLING THE RAMP START MODULE

#### Step 1

##### Adding uprights to existing build

Select the correct start module back upright (see module drawing pack for more info) Starting on the left, bring into position, ensuring to locate all tubes in correct socket positions. Tighten fittings to hold point. Adjust leg height to ensure ramp is at the correct angle. Repeat for right hand side. At this point, verify that all tubes are present and correct, legs are all in place and at the correct height, and all fittings are in the 'hold point' position.



#### Step 2

##### Inserting VBI side panel or guardrail tube

Starting on the lefthand side, insert the VBI panel or guardrail tube into the present upright, tighten fittings to hold point. Repeat for right hand side.



**Note:** Imagery used is of VBI construction, all steps are the same for the tube-only variant, in addition, for all module additions, the proceeding module is always assembled onto the existing module.

## Step 3

### Adding intermediate uprights to existing build

Select the correct start module intermediate upright (see module drawing pack for more info) Starting on the left, bring into position, ensuring to locate all tubes in correct socket positions. Tighten fittings to hold point. Adjust leg height to ensure ramp is at the correct angle. Repeat for right hand side. At this point, verify that all tubes are present and correct, legs are all in place and at the correct height, and all fittings are in the 'hold point' position.



## Step 4

### Inserting VBI side panel or guardrail tube

Starting on the lefthand side, insert the VBI panel or guardrail tube into the previously built module, add powdercoated handrails, tighten fittings to hold point. Secure handrail to saddle fittings using supplied screws (Fig. 4.a)



Fig. 4a

### 5.6 ASSEMBLING THE RAMP START MODULE

#### Step 5

##### Adding front uprights to existing build

Select the correct start module front upright (see module drawing pack for more info). Starting on the left, bring into position, ensuring to locate all tubes in correct socket positions. Tighten fittings to hold point. Adjust leg height to ensure ramp is at the correct angle. Repeat for right hand side. At this point, verify that all tubes are present and correct, legs are all in place and at the correct height, and all fittings are in the 'hold point' position. Add powdercoated D return detail to end, tighten fittings to hold point position.



**Note:** Imagery used is of VBI construction, all steps are the same for the tube-only variant, in addition, for all module additions, the proceeding module is always assembled onto the existing module.

## Step 6

### Adding horizontal tread support rails

Locate tread support rails, ensuring A10 fittings are open, and locking pins are present and accessible. Using module drawings to identify location, place all horizontals in place, close A10 fittings, add dowel to close, tighten grub screws to hold point. Add tread support bar into position shown in drawing pack, secure with tek screw into the lower tube (Fig. 6.a).



Fig. 6a



## 5.6 ASSEMBLING THE RAMP START MODULE

### Step 7

#### Adding tread support extrusions and fillet brackets

Locate tread support extrusions, lay out on part built module as shown in drawing pack. Connect to existing extrusion, then using Tek screws, secure the angle bracket to the cross tube (see Fig. 10b). Repeat for all brackets. Add tread support fillet (part no. TRHLD0030) to fitted extrusions, ensuring that the underside is in contact with the ground. Where extrusions need to be joined, the WW1003030 part should be used and assembled as per Fig. 10c.

Fig. 10b

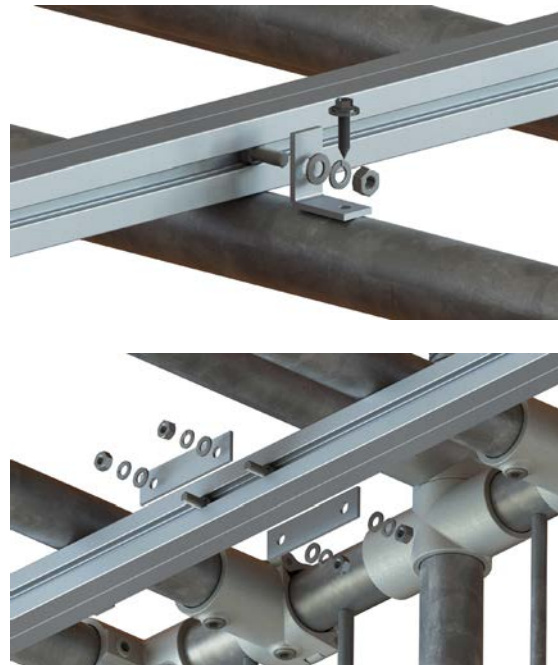

Fig. 10c





**Note:** Imagery used is of VBI construction, all steps are the same for the tube-only variant, in addition, for all module additions, the proceeding module is always assembled onto the existing module.

## Step 8

### Adding treads

Locate treads, lay out first two treads, starting at the built end, ensuring tread finishes flush with the end of the extrusion. Using the supplied U clips and self tapping screws, use 6 off (2 per extrusion, equally spaced see Fig. 11a).

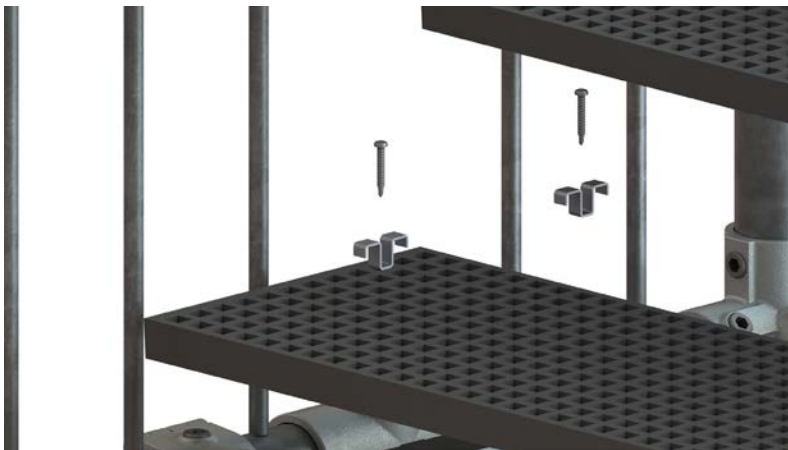

Fig. 11a



## 5.6 ASSEMBLING THE RAMP START MODULE

### Step 9

#### Adding remaining treads and toeboards

Add remaining treads, secure as in step 11 on page 29. Add toeboards to left and right of treads, secure through face of the toeboard using tek screw into the tread.

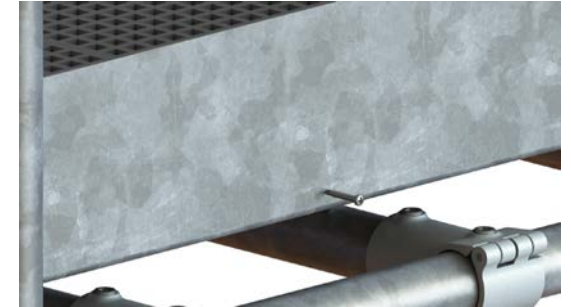

## 5.7 ADDING OPTIONAL STAIRCASE ASSEMBLY

### Step 1

#### Removing VBI panel on existing Kee Access ramp system

In order to add the staircase to an existing system, firstly an opening must be made on a flat section. To do this, the VBI panel or tube. Firstly undo the grubscrews in the upright fittings, and A10 add on fittings. Using a suitable drift and hammer, remove the pins from one half of the A10 fitting and swivel open. Pushing the uprights to one side, remove the VBI panel from the assembly.

**\*If stair is not being retrofitted, ignore step 1 and proceed to step 2**



## 5.7 ADDING OPTIONAL STAIRCASE ASSEMBLY

### Step 2

#### Addition of A10's and corner VBI

Add A10 fittings to uprights as shown, and to position noted in drawing pack. Add lower rail assembly, close existing lower A10 fittings, reinsert pin as shown to lock fitting in position, tighten grubscrews to hold point. Add left/right hand VBI panels, tighten all grubscrews to hold point.



**Note:** Imagery used is of VBI construction, all steps are the same for the tube-only variant, in addition, for all module additions, the proceeding module is always assembled onto the existing module.

## Step 3

### Adding stair rear uprights

Locate correct rear uprights (check drawing pack for detail) starting with the left hand upright, add the lower rail to the assembly and bring the right hand into position. Tighten to hold point. Ensuring that all tube sockets are correctly located add the left and right uprights to the assembly

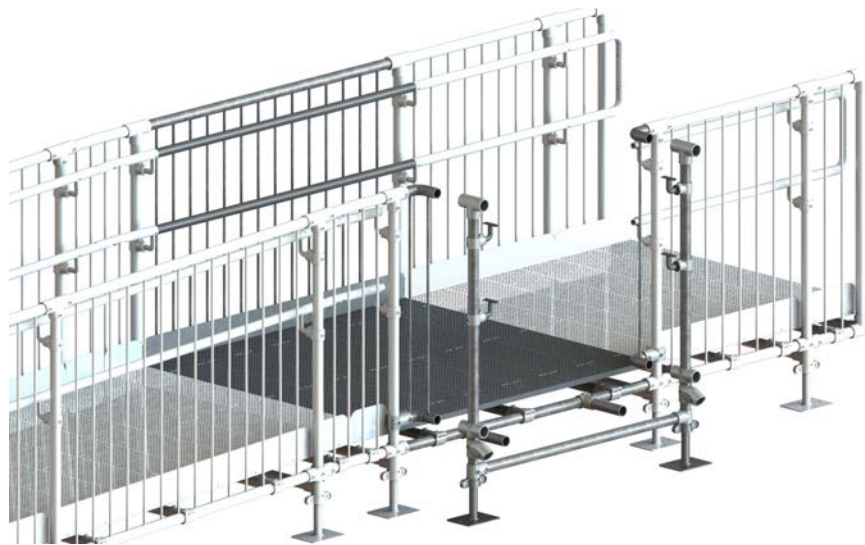

### 5.7 ADDING OPTIONAL STAIRCASE ASSEMBLY

#### Step 4

##### Adding lower stair case components

Add complete stair tread framework as a unit, taking care to ensure that the tube is correctly located into the lower 29 and 10 fitting on the existing structure. Ensure that 72 fittings are horizontal. Tighten all grubscrews to hold point.

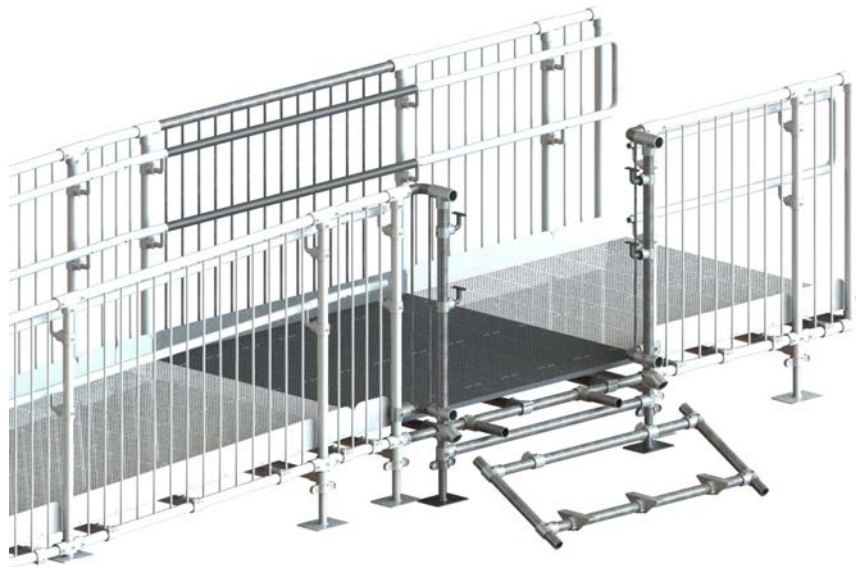

**Note:** Imagery used is of VBI construction, all steps are the same for the tube-only variant, in addition, for all module additions, the proceeding module is always assembled onto the existing module.

## Step 5

**Adding VBI panels or tube to the respective fittings, tighten to hold point**

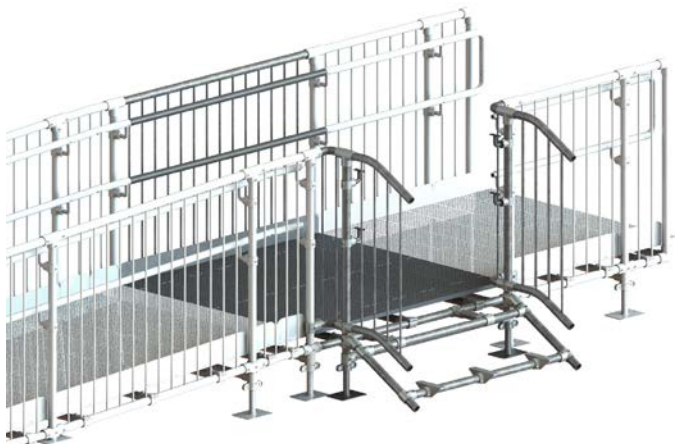

## Step 6

**Adding front uprights into position**

Locate correct stair front uprights, taking care to ensure handing is correct. Ensure tube or VBI panels are located into the fittings on the upright correctly, tighten fitting grubscrews to hold point.



### 5.7 ADDING OPTIONAL STAIRCASE ASSEMBLY

#### Step 7

**Add extrusions to cross tubes, to dimensions shown in the drawing pack**

Fix stair tread extrusions with supplied tek screws, and fit top tread extrusion to tube by securing through the 90° angle bracket with a tek screw.

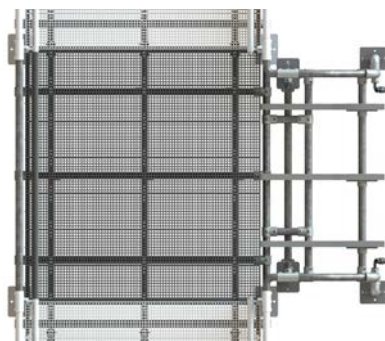



**Note:** Imagery used is of VBI construction, all steps are the same for the tube-only variant, in addition, for all module additions, the proceeding module is always assembled onto the existing module.

## Step 8

**Add extrusions to cross tubes, to dimensions shown in the drawing pack**

Fix stair tread extrusions with supplied tek screws, and fit top tread extrusion to tube by securing through the 90° angle brakcet with a tek screw.

TOP TREAD

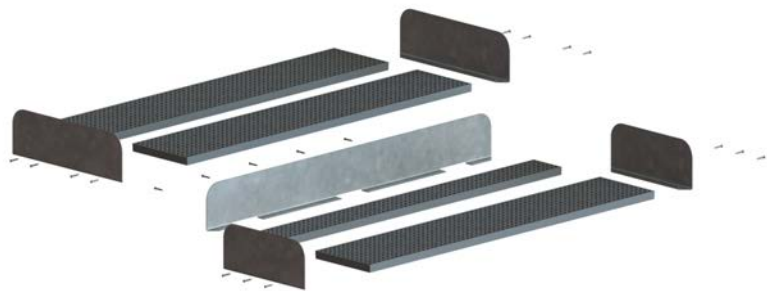

STAIR TREAD



## Step 9

Add assembled treads to extrusions using top clips as per ramp assembly method.



## 5.7 ADDING OPTIONAL STAIRCASE ASSEMBLY

### Step 10

#### Adding handrail

Locate all correct powdercoated tubes as detailed in assembly drawing, starting at the stairs landing, secure horizontals in place. Work down the stairs, ensuring to locate tubes correctly onto handrail saddles, and secure with DDA screw. Once all fittings are assembled to drawing and handrail is continuous, tighten all fittings to hold point ensuring D return is horizontal and inline.



### Step 11

#### Final verification

Ensure treads are level, and if adjustment is needed remove stair treads and repeat step 4. Ensure all handrail is smooth and continuous, and that all toeboards are present and secure.



## 5.8 FINAL CHECKS

### Step 12

#### Final checks

Ensure all grub screws are correctly tightened to 39Nm.

### !IMPORTANT! Final Verification

Check that the ramp angle is correct at all junctures, that feet are all present and correctly adjusted, all clips are present and secured in the GRP, handrails are all present and smooth and continuous. Ensure that ALL grub screws are Torque'd to 39Nm, and marked to that effect to ensure none are missed.



### 6. KEE ACCESS RAMP SYSTEM RECERTIFICATION

- Periodic inspections by a competent person are recommended by the manufacturer. In UK/Europe these are required under Regulation 5 of the Workplace (Health, Safety & Welfare) Regulations, the Work at Height Regulations and BS EN 365. The frequency will depend upon the environment, location and usage but should be at least every 12 months.
- Walk and visually inspect the complete installed system in relation to the clients general needs. Establish if any modifications and/or additional products are required to reflect any refurbishment requirements or additional access requirements which have been identified and require access.
- Check installation configuration is complete as per the original installation drawing/plan.
- Ensure the system has not been modified or tampered with by unauthorised persons.
- Check all base feet are in contact with the substrate.
- Check all grub screws are in place and correctly torqued.
- Check the general height and level of the system including the leg centres and ramp overall conFig.uration.
- (This only tends to be an issue if the system has been tampered with between inspections).
- Any galvanised components showing signs of corrosion should be wire brushed thoroughly and galvanised spray/paint applied as appropriate. If rusted significantly, take digital photographs and include these in the inspection report.
- Where toe-boards are fitted check the brackets that support the toe-board are in place and sufficiently torqued.
- Where applicable check fixings to walls/structures are in place and sufficiently torqued.

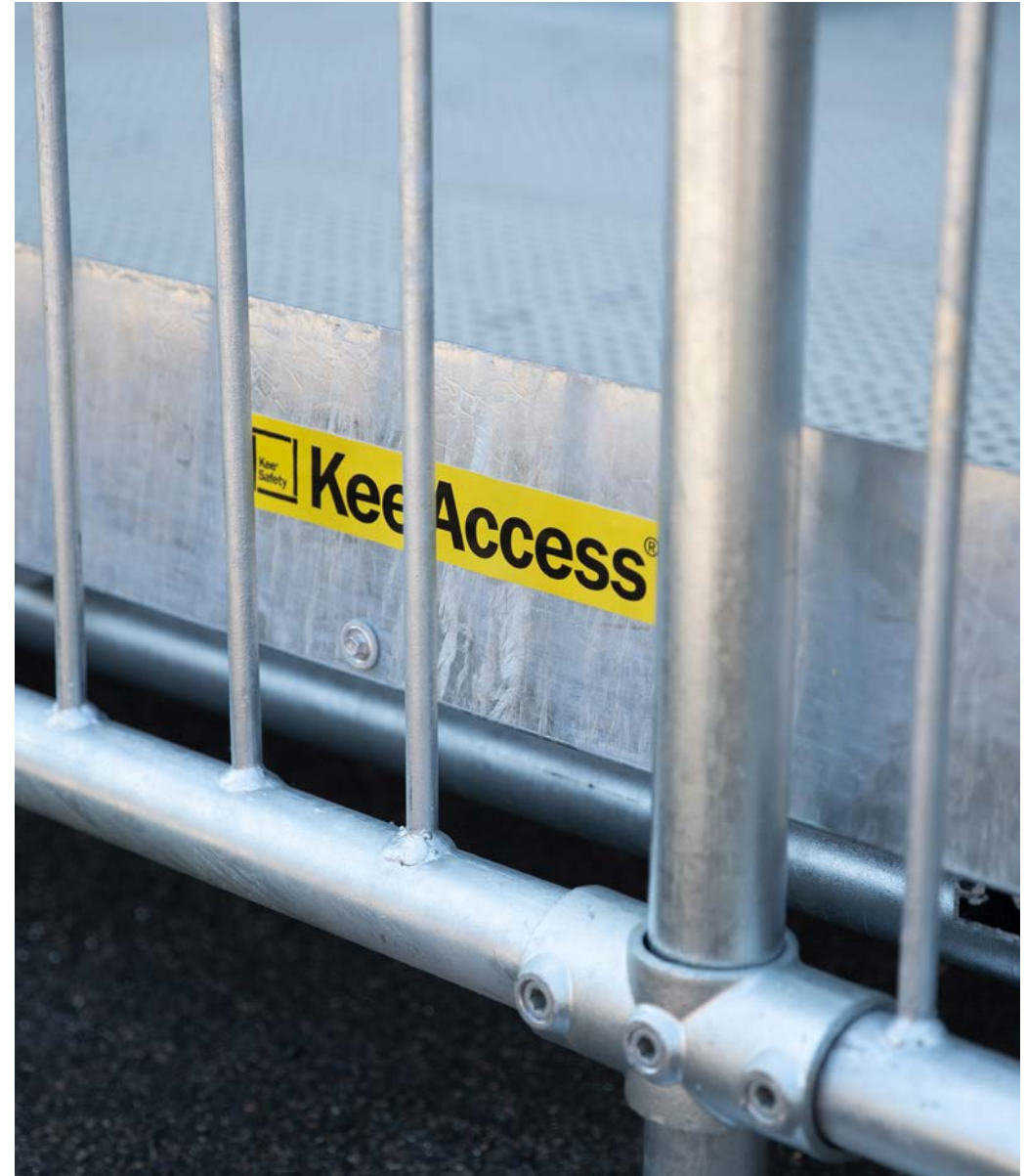





**Tel:** (877) 505 5003

**Email:** [info@keesafety.ca](mailto:info@keesafety.ca)

**Web:** [www.keesafety.ca](http://www.keesafety.ca)

**For technical support contact:**  
[technical@keesafety.com](mailto:technical@keesafety.com)

KEE Access ramp is a registered trademark of Kee Safety Limited. Whilst every effort has been made to ensure the accuracy of the information contained in this brochure Kee Safety Group Ltd and/or its subsidiaries cannot be held responsible for any errors or omissions. Kee Safety Group Ltd, its affiliates and subsidiaries reserve the right to alter or withdraw products without prior notice. Kee Safety Group Ltd and/or its subsidiaries accepts no responsibility for any loss or damage arising from improper use of their products.  
©2021 Kee Safety Limited Ltd. All Rights Reserved.