



SEPARATING PEOPLE FROM HAZARDS

Safety Components Catalog



- SAFETY COMPLIANT
- NO WELDING OR THREADING
- LIGHTWEIGHT AND VERSATILE COMPONENTS
- HIGH CORROSION-RESISTANCE



safety railing solutions



pre-galvanized cast iron fittings for the construction of steel tubular structures



components manufactured from a high grade Aluminum Silicon Magnesium Alloy for creating lightweight tubular structures



barrier railing system designed to meet ADA (Americans with Disabilities Act) requirements

KEE SAFETY has been building and designing railings and the components used to create rugged pipe structures for over 75 years. The simplicity in the design of these systems is due to the modularity of its parts. Whether you need to protect people, equipment, or your on-site inventory, KEE SAFETY provides the most cost effective safe solutions to your barrier requirements. When you need a safe, reliable, durable and versatile barrier system, there is only one company to think of: KEE SAFETY.

Safety

KEE SAFETY regularly monitors all new safety standards and directives to ensure the highest levels of safety. KEE SAFETY understands the requirements laid out in today's numerous safety bulletins: OSHA, IBC U.S. Coast Guard, Ontario Building Code, ANSI, Health and Safety, EU Directives & CDM Regulations to name just a few. Either in the factory, on the construction site, or along the ADA ramp, KEE SAFETY solutions not only meet but exceed the current safety requirements for maximum protection.

Quality

Quality is the overriding priority when manufacturing KEE SAFETY components. It begins in the foundry where all fittings are manufactured and galvanized to ISO Standard BS EN ISO 1461 and subject to stringent inspection upon completion. The components are TÜV certified for strength, manufacturing quality and consistency.

Solutions

From simple protection for loading docks or walkways, to safety railings in aggressive coastal environments or the protection of road bridges and culverts, KEE SAFETY can provide a strategic integrated safety solution to meet your safety requirements with absolute confidence.



Technical & Specifying Information	04
KEE KLAMP Components	06
KEE LITE Components	24
KEE ACCESS Components	32
Accessories	36
Pipe Choices	37
Building Compliant Railings	38
Assembly and Installation	40
Load Tables	44
Vibration Test	47
Gallery	48
Fax Inquiry Sheet	50
KEE PROJECTS	51





Galvanized Steel

Schedule 40 and Schedule 80; size 1/4" to 2" IPS; nominal mill lengths of 21' cut to your projects' exact length requirements

Powder Coating

Durable, corrosion preventing polyester coating applied to already galvanized/anodized products; available in any RAL color

Aluminum

Alloy 6105-T5 with an anodized finish; size range 3/4" to 2" IPS; nominal mill lengths of 12' and 24' cut to your projects' exact length requirements

Antimicrobial Coating

Defense against the growth of potentially harmful invisible bacteria and fungi; this powder coating can be applied in a wide range of RAL colors

Pipe for your Structure

KEE KLAMP safety components are produced in a range of standard sizes to suit Schedule 40 steel pipe, sizes 1/4" nominal bore to 2" nominal bore; also equivalent sizes of tubing in other materials.

Tubing of other specifications can be used, providing the outside diameter is compatible with Schedule 40 pipe. Pipe with a wall thickness of less than 1/8" can only be used in lightly loaded structure.

pipe reference	component inner dia (in.)	nominal bore (in.)	pipe outer dia (in.)	tube outer dia (in.)
2	0.59	1/4	0.540	0.531
3	0.76	3/8	0.675	0.688
4	0.87	1/2	0.840	0.844
5	1.09	3/4	1.050	1.000
6	1.38	1	1.315	1.313
7	1.72	1-1/4	1.660	1.625
8	1.94	1-1/2	1.900	1.875
9	2.41	2	2.375	2.375

Note:
KEE SAFETY can provide general guidance on the use of the fittings detailed in this catalog. However, the nature of the product means that the ultimate responsibility for selecting the correct fitting for an application rests with the customer. The customer should also ensure that any existing structure to which a KEE SAFETY component is being secured is of sufficient strength to support both the weight of the KEE SAFETY construction and the imposed loads applied, including wind loads, snow loads, and any other superimposed loads.

TÜV Approval

KEE SAFETY components are approved by TÜV, Europe's leading independent testing house. The maximum load of each fitting type is as stated on the TÜV Certificate, a copy of which is available upon request. For an up-to-date TÜV listing see our website at www.keesafety.com.

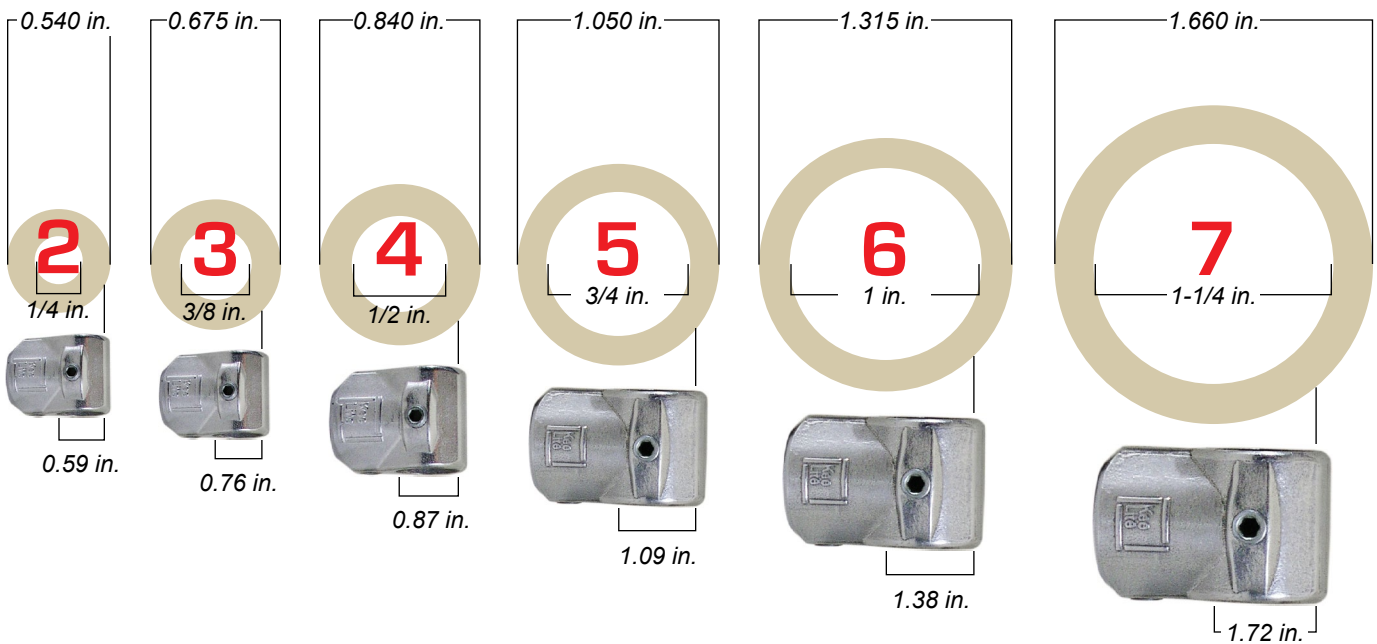

Selecting Kee Safety Components

Every fitting is illustrated and accompanied by a table of sizes and weights. Each fitting has a simple numerical code reference, which is unique and differentiates it from every other fitting. The code defines the type of fitting and the pipe size or sizes it is designed to receive.

— component type, name, and description —

25 Three Socket Tee

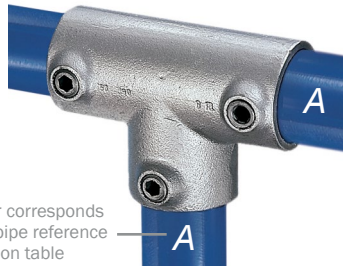

letter corresponds with pipe reference on table

Most commonly used as the 90° joint between the top rail and an intermediate upright on safety railing. As there are two socket screws in the sleeve, this fitting can be used where a join is required in the horizontal pipe. The Type 10 fitting can be used as an alternative when a join in the pipe is not required.

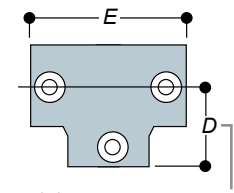

each letter in drawing has a corresponding measurement on table

type	pipe reference			measurements (in.)			weight (lb.)
	A	B	C	D	E	F	
25-4	4			1.34	2.68		0.40
25-5	5			1.61	3.23		0.82
25-6	6			1.81	3.62		1.08
25-7	7			2.36	4.72		1.87
25-8	8			2.68	5.35		2.40
25-9	9			3.35	6.61		3.84

first number preceding the dash identifies the component type

single digit following the dash defines pipe size. (Two digits after the dash indicate that the fitting is designed to receive two sizes of pipe, and likewise with three digits.) See below for pipe reference digits related to actual pipe dimensions.

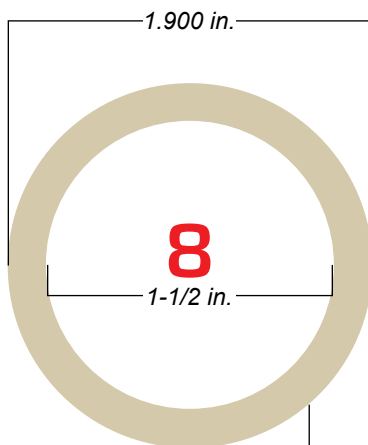

1.94 in.

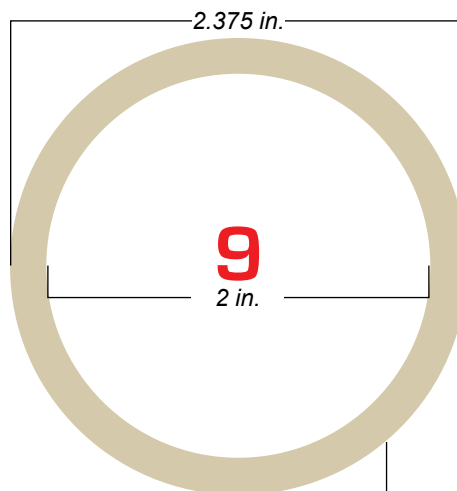

2.41 in.

Specifying Components

05 52 00 METAL RAILINGS

PART 1-1 GENERAL

- 1.1 SCOPE
- 1.2 RELATED WORK
- 1.3 RAILING STRUCTURAL REQUIREMENTS
- 1.4 SUBMITTALS
- 1.5 QUALITY ASSURANCE

PART 2-2 PRODUCTS

2.1 MANUFACTURER

A. Manufacturer of handrail, guardrail or railing systems shall be the following except where otherwise noted on the Drawings:

1. Kee Safety, Inc., Buffalo, NY, USA
1-800-851-5181
2. Kee Safety, Ltd., Concord, ON, Canada
1-877-505-5003

2.2 SYSTEMS

A. Handrails and Guardrails: Provide pipe, KEE KLAMP or KEE LITE fittings, and accessories as indicated or required to match design indicated in the Drawings.

B. Guardrails for Hatches and Openings: Coordinate with Section 07 72 00, and provide KEE HATCH Safety Railing system consisting of a top rail, mid rail, and chain or swinging gate, with the hatch curb acting as the toe plate. Extended railing system to a height of at least 42 inches (1067 mm) from the finished roof deck.

C. Roof Edge Guardrails: Coordinate with Section 07 72 00, and provide freestanding KEE GUARD Roof Edge Protection System, including pipe railings, uprights, bases, counterweights and fittings.

2.3 METALS

A. Pipe

1. Steel Pipe: ASTM A 53
2. Aluminum Pipe: Alloy 6105-T5 conforming to ASTM B 221

B. Fittings and Castings:

1. Cast Iron Fittings or Castings to comply with ASTM A 47
2. Hot Dip Galvanized finish to comply with BS EN ISO 1461
3. Aluminum Alloy Fittings or Castings conforming to ASTM A 356 T-6
4. Brackets, Flanges, and Anchors: Cast or formed metal of same material and finish as supported rails.

2.4 OTHER MATERIALS

2.5 FABRICATION-GENERAL

PART 3-3 EXECUTION

- 3.1 EXAMINATION AND PREPARATION
- 3.2 INSTALLATION
- 3.3 JOB CLOSE OUT

A brief three part specification for KEE SAFETY components is shown above for quick reference. The full specification is available for download on the KEE SAFETY website at www.keesafety.com.



Galvanized Steel Components

Steel pipe is an inherently efficient structural component. It is strong, has no sharp corners, and is readily available worldwide. The difficulty in using steel pipe to form structures arises when joining. Threaded pipe must be supplied in set lengths making for zero flexibility in installation. Welding is labor intensive, requires a highly skilled workforce, and specialized equipment.

The answer is KEE KLAMP components. The underlying principle is simple but highly effective: use slip-on components to create versatile and rigid tubular structures. The KEE KLAMP principle has been developed and refined for more than 75 years resulting in an extensive range of components suited for any need.

Engineering

The engineering principle behind the KEE KLAMP component is the foundation of the most versatile pipe connection system available. We provide the versatility needed to achieve virtually any structure configuration.

KEE KLAMP fittings are iron castings manufactured to the requirements of ASTM A47-77-32510. We have engineered a range of components to suit eight different sizes of pipe. Hexagon set screws firmly lock the component to the pipe. Set screws are manufactured in case hardened steel and are protected against corrosion with our unique protectant called KEE KOAT.

A KEE KLAMP component (size 5 to 9) can support an axial load of 2000 lbs. per set screw with the set screw tightened to a torque of 29 lbs./ft. (*rating includes a safety factor of 2:1*). This is normally obtained when the set screw is fully tightened using a ratchet wrench.

Fittings by Function

Bases

- 62.....Standard Railing
- 64.....Vertical Railing
- 65.....Horizontal Railing
- 66.....Ground
- 69.....Rail w/ Toe Adaptor
- 262.....Round Flange

Clips

- 79.....Sheeting
- 81.....Single Sided
- 82.....Double Sided
- 105.....Sheeting w/o hardware
- 126.....Galvanized

Couplings

- 14.....Straight
- 18.....Internal
- 145.....Crossover

Crosses

- 26.....Two Socket
- A26.....Split Two Socket
- 28.....Two Socket Custom
- 30.....30°-45° Adjustable
- 35.....Three Socket
- A35.....Split Three Socket
- 40.....Four Socket
- A40.....Split Four Socket
- 89.....Two Socket Angle
- 91.....PGR Two Socket Cross

Crossovers

- 17.....Clamp-on
- 45.....Crossover
- 46.....Combination Socket Tee
- A45.....Split
- 121.....Corner

Elbows

- 15.....90°
- 20.....Side Outlet
- 55.....Obtuse Angle
- BC53.....Swivel
- 56.....Acute Angle
- 87.....Angle
- 92.....PGR

Flanges

- 31.....Pallet
- C58.....Swivel
- 59.....Spigot
- 60.....Extra Heavy
- 61.....Flange
- 63.....Angle Base
- 67.....Angle
- 68.....Wall
- 70.....Rail Support
- 115.....Wall
- 265.....Offset Rail Wall
- 316.....Parapet

Swivel Sockets

- C50.....Single Combination
- F50.....Female Single
- M50.....Male Single
- MH50.....Male Single Horizontal
- C51.....Double
- M51.....Male Double Member
- MH51.....Male Double Horizontal Member
- C52.....Corner
- M52.....Male Corner
- 78/83.....Gate Hinge Set
- F151.....Gate Fitting

Tab Panels

- P51.....Offset Double w/ Slot
- P50.....Offset Sing. w/ Slot
- P57.....Single w/ Slot
- P58.....Double w/ CSH

Tees/Sockets

- 10.....Single Socket
- A10.....Split Single Socket
- 12.....45° Single Socket
- A12.....Split 45° Single Socket
- 16.....Clamp-on
- 19.....Adjustable Side Outlet
- 21.....90° Side Outlet
- A21.....Split 90° Side Outlet
- 25.....Three Socket
- 27.....Three Socket Custom

- 29.....30°-60° Single Socket
- 46.....Combination Crossover
- 86.....Angle
- 88.....Three Socket Angle
- 90.....PGR Three Socket
- 93.....Pedestrian Guard Rail
- 114.....Swivel

Plugs

- 77.....Plastic
- 84.....Malleable

Miscellaneous

- 71.....Weather Cap
- 72.....Stair Tread Support
- 75.....Collar
- 76.....Hook
- 95.....PGR Internal Spigot
- 97.....Set Screw
- 98.....Ratchet Handle w/ Bits
- 99.....Hex Key
- 100.....Plastic Set Screw Caps
- S115.....Spacer Plate
- 118.....Rose Cover
- 350.....Eaves Fitting
- 351.....Ridge Fitting
- 12585.....Fold Up Hex Key

10 Single Socket Tee

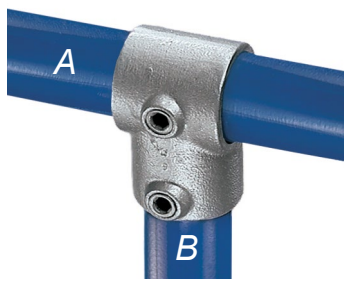

Designed to give a 90° butt joint between two pipes. Frequently used for the joint between end uprights and the middle rail where the railing site is straight and level. Also used for base ties on racking. This fitting cannot be used where through pipe is required to be joined within the fitting. Type 25 should be used when a join in the pipe is necessary.

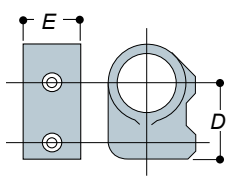

type	pipe reference		measurements (in.)		weight (lb.)
	A	B	D	E	
10-2	2	2	1.00	0.77	0.04
10-3	3	3	1.13	0.94	0.15
10-4	4	4	1.36	1.20	0.29
10-5	5	5	1.63	1.47	0.51
10-6	6	6	1.81	1.84	0.64
10-65	6	5	1.75	1.42	0.55
10-67	6	7	2.20	2.06	0.95
10-7	7	7	2.38	2.16	0.99
10-75	7	5	2.25	1.44	0.71
10-76	7	6	2.25	1.80	0.95
10-78	7	8	2.88	2.38	1.39
10-8	8	8	2.69	2.38	1.28
10-87	8	7	2.47	2.03	1.10
10-9	9	9	3.31	2.88	2.14
10-98	9	8	2.94	2.50	1.43

A10-8 Split Single Socket Tee

1-1/2"

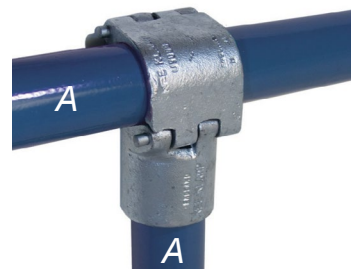

Designed to allow additions or extensions to existing structures without the need for dismantling. Pipe must not be joined within the fitting. Fitting has strength and function comparable to Type 10 components.

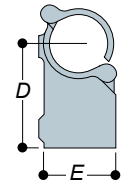

type	pipe ref.	measurements (in.)		weight (lb.)
	A	D	E	
A10-8	8	3.46	2.36	1.59

12 45° Single Socket Tee

Engineered to create 45 angles. This component is most frequently used for bracing and struts.

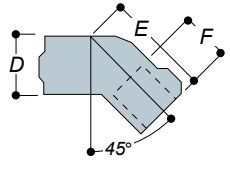
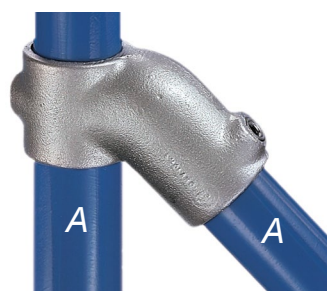

type	pipe ref.	measurements (in.)			weight (lb.)
	A	D	E	F	
12-5	5	1.46	2.83	1.38	0.66
12-6	6	1.73	3.35	1.38	0.95
12-7	7	2.17	3.70	1.58	1.56
12-8	8	2.36	4.25	1.58	2.02

A10-7 Split Single Socket Tee

1-1/4"

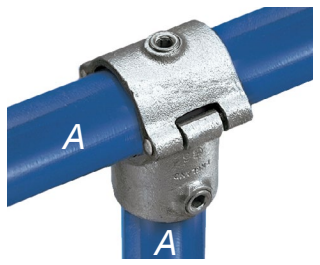

Designed to allow additions or extensions to existing structures without the need for dismantling. Pipe must not be joined within the fitting. Fitting has strength and function comparable to Type 10 components.

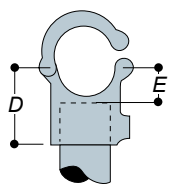

type	pipe ref.	measurements (in.)		weight (lb.)
	A	D	E	
A10-7	7	2.36	1.10	1.26

A12 Split 45° Single Socket Tee

The unique hinge and pin system of this fitting enables existing structures to be easily extended without the need for dismantling. This fitting is most frequently used for bracing and struts.

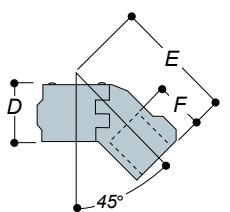
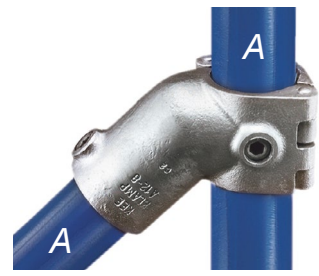

type	pipe ref.	measurements (in.)			weight (lb.)
	A	D	E	F	
A12-8	8	2.36	4.80	2.05	2.36

14 Straight Coupling

Designed to form an in-line joint between two pieces of pipe of the same size. Where a constant diameter is required along the outside of the pipe (such as ADA handrail or garment storage) an internal spigot (Type 18 or Type 514-8) should be considered.

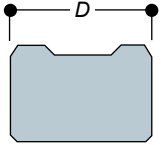
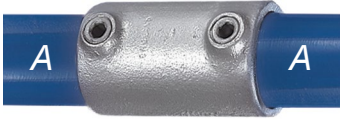

type	pipe ref.	measurements (in.)	weight (lb.)
	A	D	
14-4	4	2.28	0.31
14-5	5	3.03	0.60
14-6	6	3.50	0.86
14-7	7	4.01	1.15
14-8	8	4.09	1.41
14-9	9	4.88	2.38

17 Clamp-on Crossover

Designed to provide a 90° crossover joint. Can be added to an existing structure. Pipe should not be joined within this fitting. For alternative fitting, see Type 45 or Type A45.

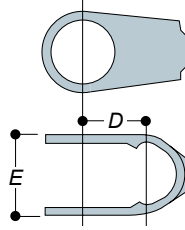
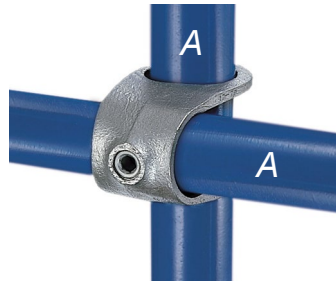

type	pipe ref.	measurements (in.)	weight (lb.)
	A	D E	
17-5	5	1.06 1.61	0.33
17-6	6	1.34 1.89	0.51
17-7	7	1.69 2.48	0.95
17-8	8	1.93 2.68	1.23
17-9	9	2.40 3.07	1.98

15 90° Elbow

A 90° elbow joint, most frequently used as an end joint for the top rail of safety railing on a level site.

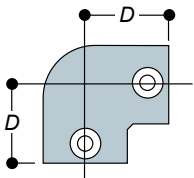
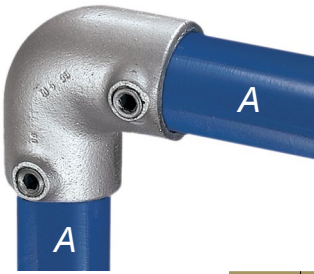

type	pipe ref.	measurements (in.)	weight (lb.)
	A	D	
15-4	4	1.33	0.29
15-5	5	1.61	0.60
15-6	6	1.81	0.86
15-7	7	2.36	1.48
15-8	8	2.67	1.70
15-9	9	3.34	2.82

18 Internal Coupling

An internal spigot providing a flush joint between two pipes of the same diameter. Not as strong as Type 14 and must not be used where a direct tensile load is applied. This fitting can only be used with Schedule 40 steel pipe.

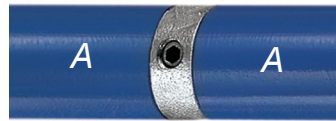

DANGER: Type 18 coupling must not be used as a load bearing joint.

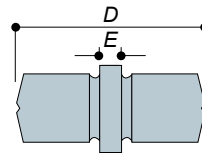

type	pipe ref.	measurements (in.)	weight (lb.)
	A	D E	
18-6	6	2.99 0.79	0.57
18-7	7	2.99 0.79	0.84
18-8	8	3.74 0.79	1.19

16 Clamp-on Tee

Widely used for adding to and modifying existing structures. This performs the same function as a Type 10, but because of its open socket, it can be added to a complete structure. For alternative fitting, see Type A10. Type 25, or Type A26-8 with Type 84-848 top cap, should be used when a join in the pipe is necessary.

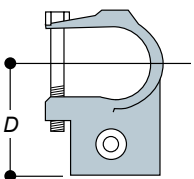
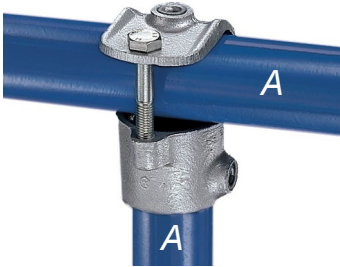

type	pipe ref.	measurements (in.)	weight (lb.)
	A	D	
16-5	5	1.97	0.64
16-6	6	2.09	0.73
16-7	7	2.64	1.30
16-8	8	3.03	1.32
16-9	9	3.54	2.03

19 Adjustable Side Outlet Tee

Used in pairs to form variable angle joints between 90° and 180°. When calculating cutting lengths for pipe, dimension 'E' should be subtracted to give true pipe length. Types 19-8 and 19-85 can produce an angle range between 60° and 180°.

Note: pairs sold and priced separately in UK, France, and Germany.

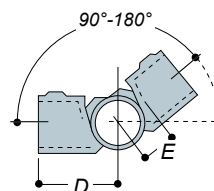
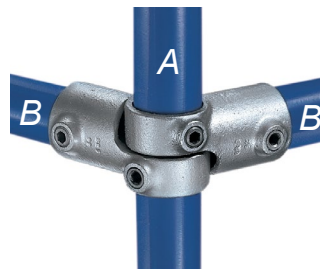

type	pipe ref.	measurements (in.)	weight (lb.)
	A B	D E	
19-5	5 5	2.36 1.22	0.44
19-6	6 6	2.28 1.30	0.64
19-7	7 7	2.87 1.57	0.90
19-8	8 8	3.54 2.17	1.17
19-85	8 5	2.87 1.77	1.43
19-9	9 9	4.33 1.93	2.18

20 Side Outlet Elbow

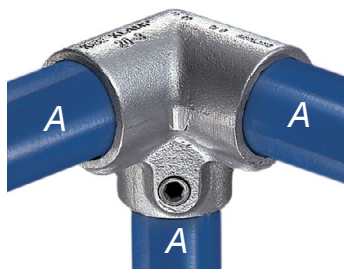

A 90° corner joint most frequently used for the top rail of safety railing. It can also be considered for the corner joint of benches, work tables, and other rectangular structures.

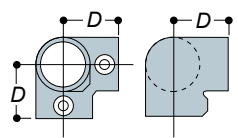

type	pipe ref.	measurements (in.)		weight (lb.)
	A	D		
20-4	4	1.34	0.37	
20-5	5	1.61	0.84	
20-6	6	1.81	1.06	
20-7	7	2.36	1.79	
20-8	8	2.68	2.49	
20-9	9	3.35	4.01	

25 Three Socket Tee

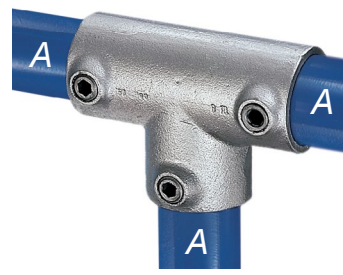

Most commonly used as the 90° joint between the top rail and an intermediate upright on safety railing. As there are two socket set screws in the sleeve, this fitting can be used where a join is required in the horizontal pipe. The Type 10 fitting can be used as an alternative when a join in the pipe is not required.

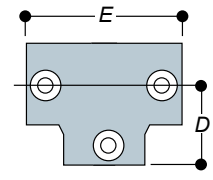

type	pipe ref.	meas. (in.)		weight (lb.)
	A	D	E	
25-4	4	1.34	2.68	0.40
25-5	5	1.61	3.23	0.82
25-6	6	1.81	3.62	1.08
25-7	7	2.36	4.72	1.87
25-8	8	2.68	5.35	2.40
25-9	9	3.35	6.61	3.84

21 90° Side Outlet Tee

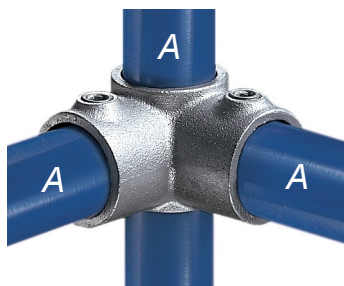

Most frequently paired with Type 20 to give a 90° corner joint for the middle rail of safety railing and other rectangular structures. The upright passes through the fitting.

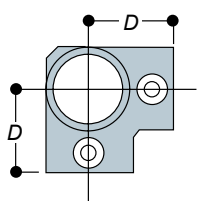

type	pipe ref.	measurements (in.)		weight (lb.)
	A	D		
21-4	4	1.34	0.31	
21-5	5	1.61	0.62	
21-6	6	1.81	0.90	
21-7	7	2.36	1.52	
21-8	8	2.68	1.87	
21-9	9	3.35	3.00	

26 Two Socket Cross

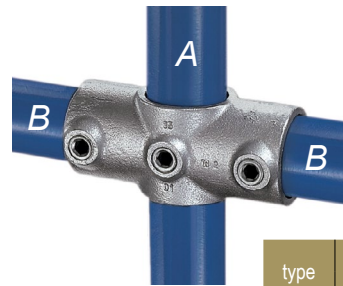

Usually paired with Type 25 to give a 90° joint between the middle rail and an intermediate upright on safety railing. The upright passes through the fitting.

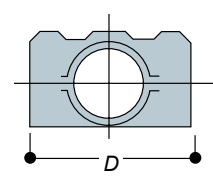

type	pipe reference		meas. (in.)	weight (lb.)
	A	B	D	
26-4	4	4	2.68	0.29
26-5	5	5	3.23	0.60
26-6	6	6	3.62	0.88
26-7	7	7	4.72	1.43
26-8	8	8	5.35	1.87
26-87	8	7	4.96	1.39
26-9	9	9	6.61	3.22

A21/A26 Split Two Socket Cross/ 90° Side Outlet Tee

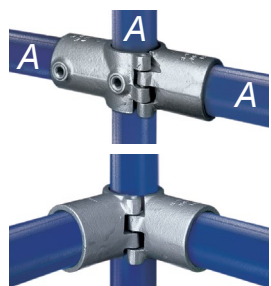

This fitting performs the same function as either Type 21 or Type 26, but because of its unique hinge pin system, it can be added to an existing tubular assembly. Type A21/A26 fittings are supplied and priced as a kit including two casting and two taper pins, which can be assembled in either configuration.

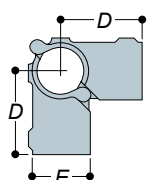

type	pipe ref.	meas. (in.)		weight (lb.)
	A	D	E	
A21/A26-8	8	3.46	2.36	2.36

27 Three Socket Custom Tee

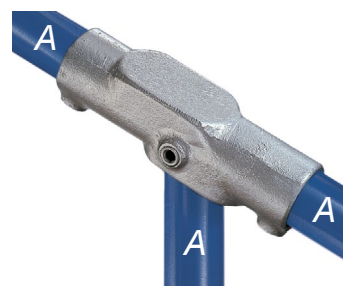

Used for safety railing on slopes between 0° and 45°, between the top rail and an intermediate upright which is required to remain vertical. Components are held in stock as blanks and then machined to individual requirements.

Note: When used in pairs, tee will not be handed. The set screws on one side will face inward on the stair or ramp. For an alternative to this fitting, see Type 29.

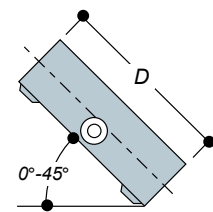

type	pipe ref.	meas. (in.)		weight before machined (lb.)
	A	D		
27-6	6	6.30	1.81	
27-7	7	7.48	2.73	
27-8	8	8.50	3.29	

28 Two Socket Custom Cross

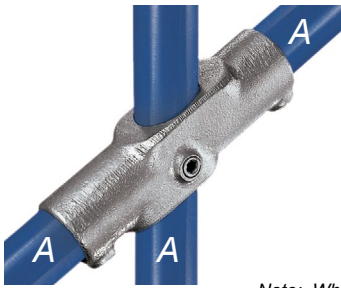

Used for safety railing on slopes between 11° and 30°, between the mid-rail and an intermediate upright which is required to remain vertical. These fittings are held in stock as blanks which are machined to individual requirements. Special order only; please specify required angle.

Note: When used in pairs, Tee will not be handed. The set screws on one side will face inward on the stair or ramp. For an alternative to this fitting, see Type 30.

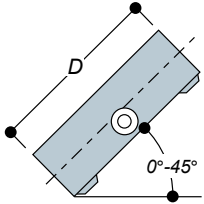

type	pipe ref.	meas. (in.)	weight before machined (lb.)
	A	D	
28-6	6	6.30	1.81
28-7	7	7.48	2.73
28-8	8	8.50	3.29

31 Pallet Flange



This fitting has been designed for the construction of post pallets. Incorporates sockets for the upright and side pipes, and a locating bell for stacking pallets. (Special order only.)

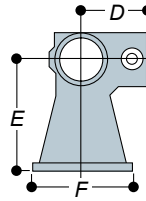

type	pipe reference	measurements (in.)			weight (lb.)
	A	D	E	F	
31-8	8	2.99	5	4.53	4.41

29 30°-60° Single Socket Tee

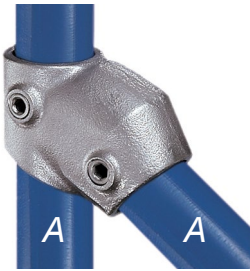

Designed as an alternative to Type 12, this adjustable fitting is most frequently used for bracing and struts. It may be used at any selected angle between 30° and 60°. As an alternative, it is possible to use Type 29 in its vertical position in place of Type 27, using Type 27 only where a join in the pipe occurs.

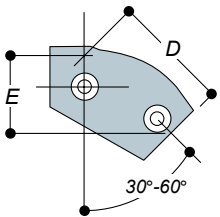

type	pipe ref.	measurements (in.)		weight (lb.)
	A	D	E	
29-6	6	3.23	2.52	0.97
29-7	7	3.66	2.91	1.39
29-8	8	4.02	2.68	2.14

35 Three Socket Cross

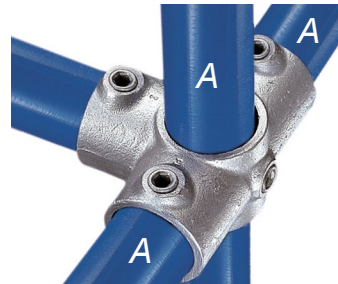

Most frequently used to tie uprights with horizontal pipes in three directions, all 90° to the upright. The upright passes through the fitting.

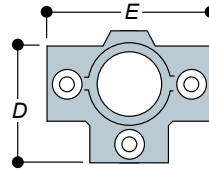

type	pipe ref.	measurements (in.)		weight (lb.)
	A	D	E	
35-4	4	1.34	2.68	0.44
35-5	5	1.61	3.23	0.77
35-6	6	1.81	3.62	0.99
36-7	7	2.36	4.72	1.70
35-8	8	2.68	5.35	2.62
35-9	9	3.35	6.61	4.04

30 30°-45° Adjustable Cross

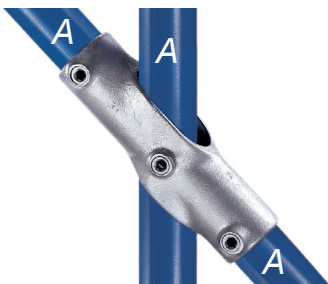

Designed as an alternative to the Type 28 fitting, this adjustable fitting can be used for railing on staircases between the mid-rail and an intermediate upright which is required to remain vertical. It may be used at any selected angle between 30° and 45°.

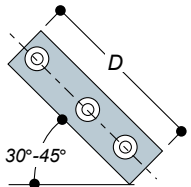

type	pipe reference	measurements (in.)	weight (lb.)
	A	D	
30-6	6	5.75	1.41
30-7	7	7.01	2.14
30-8	8	8.50	2.87

A35 Split Three Socket Cross

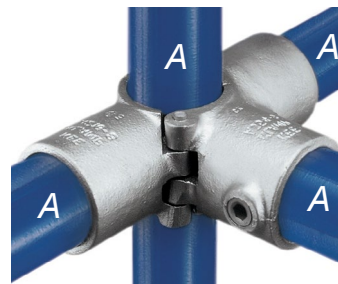

The unique hinge and pin system of this fitting enables existing structures to be easily extended without the need for dismantling. This fitting has been designed to tie an upright with horizontal pipes in three directions, all at 90° to the upright. The upright passes through the fitting.

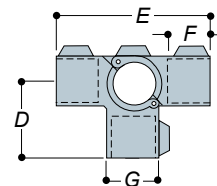

type	pipe ref.	measurements (in.)				weight (lb.)
	A	D	E	F	G	
A35-8	8	3.46	6.93	2.17	2.36	3.46

40 Four Socket Cross

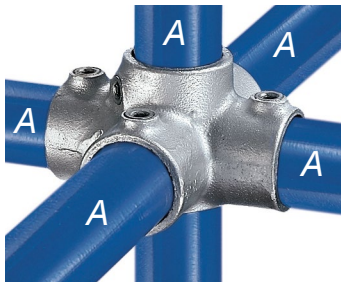

Most frequently used in multiple upright structures to tie a center upright with horizontal pipes in four directions. The upright passes through the fitting.

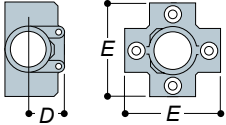

type	pipe ref.	measurements (in.)		weight (lb.)
		D	E	
40-5	5	1.26	3.23	1.12
40-6	6	1.46	3.62	1.32
40-7	7	1.81	4.72	2.32
40-8	8	2.09	5.35	3.22
40-9	9	2.44	6.61	5.07

45 Crossover

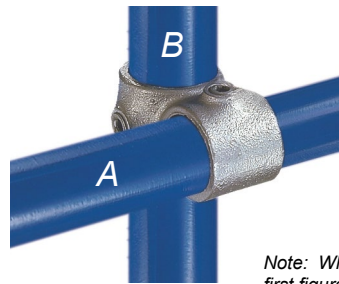

Designed to give a 90° crossover joint. Frequently used on safety railing where, to reduce cost by minimizing the pipe cuts, a continuous horizontal rail is used. Pipe cannot be joined within this fitting. It may also be used to give intermediate levels on racks etc. when horizontal ties between uprights are not required.

Note: Where dimension 'E' indicates two figures, the first figure refers to socket 'A' and the second refers to socket 'B' in the table.

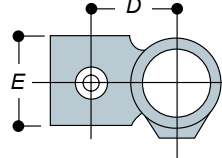

type	pipe reference		measurements (in.)			weight (lb.)
	A	B	D	E		
45-2	2	2	0.63	0.75	-	0.04
45-3	3	3	0.83	0.94	-	0.16
45-4	4	4	0.98	1.10	-	0.34
45-5	5	5	1.34	1.22	-	0.45
45-6	6	6	1.57	1.50	-	0.76
45-65	6	5	1.42	1.69	1.46	0.64
45-7	7	7	2.13	1.81	-	1.18
45-76	7	6	1.77	1.81	1.50	0.99
45-8	8	8	2.17	2.01	-	1.30
45-86	8	6	1.89	2.00	1.50	1.00
45-87	8	7	2.01	2.00	1.81	1.20
45-9	9	9	2.64	2.40	-	2.00
45-98	9	8	2.36	2.99	2.99	2.40

A40 Split Four Socket Cross

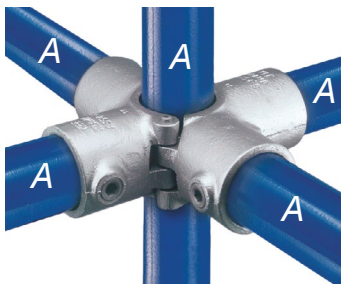

The unique hinge and pin system of this fitting enables existing structures to be easily extended without the need for dismantling. This fitting is most frequently used in multiple upright structures to tie a center upright with horizontal pipes in four directions. The upright passes through the fitting.

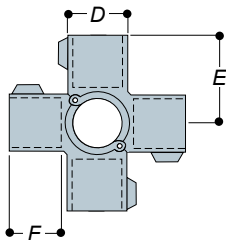

type	pipe reference	measurements (in.)			weight (lb.)
		D	E	F	
A40-8	8	2.36	3.46	2.17	4.32

A45 Split Crossover

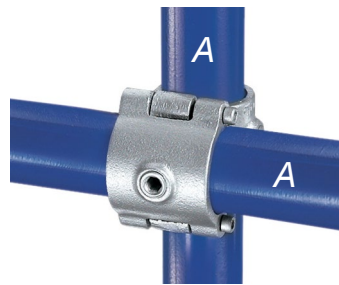

The unique hinge and pin system of this fitting enables existing structures to be easily extended without the need for dismantling. This fitting is designed to give a 90° offset crossover joint. Pipe should not be joined within the fitting. Type A45 function is comparable to Type 45 fitting.

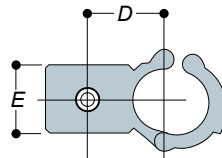

type	pipe reference	measurements (in.)		weight (lb.)
		D	E	
A45-7	7	1.93	1.81	1.43
A45-8	8	2.17	1.96	1.74

46 Combination Socket Tee and Crossover

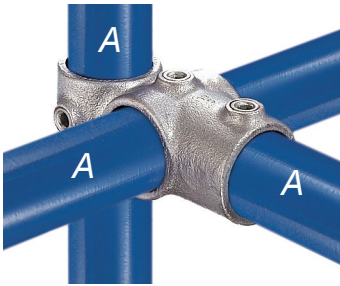

Used on racking to join horizontal carrying rails to the upright, leaving the socket to take a horizontal tie across the section. For shelved racking it is usual to have the horizontal pipe outside the upright. On pallet racking it is preferable to have the carrying rails inside the upright.

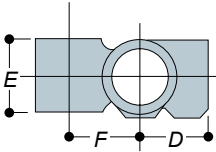

type	pipe ref.	measurements (in.)			weight (lb.)
		A	D	E	
46-4	4	1.34	1.10	0.98	0.33
46-5	5	1.61	1.22	1.34	0.66
46-6	6	1.81	1.50	1.57	1.08
46-7	7	2.36	1.81	1.93	1.52
46-8	8	2.68	2.01	2.17	2.01
46-9	9	3.35	2.40	2.64	3.40

F50 Female Single Swivel Socket Member

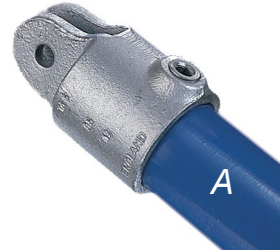

One part of combination fitting C50. The Type F50 in size 4 has only one ear, while Type F50 in sizes 5 through 9 has two ears.

Note: Type F50-4 will only mate with a Type M50-4.

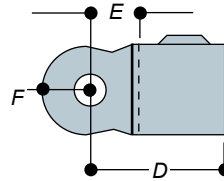

type	pipe ref.	measurements (in.)					weight (lb.)
		A	D	E	F	Ø	
F50-4	4	1.42	0.55	0.43	0.26	0.15	
F50-5	5	2.36	0.98	0.75	0.39	0.62	
F50-6	6	2.36	0.98	0.75	0.39	0.75	
F50-7	7	2.68	0.98	0.75	0.39	0.93	
F50-8	8	2.99	0.98	0.75	0.39	1.15	
F50-9	9	3.35	1.02	0.75	0.39	1.43	

Ø indicates diameter of bolt hole.

C50 Single Swivel Socket

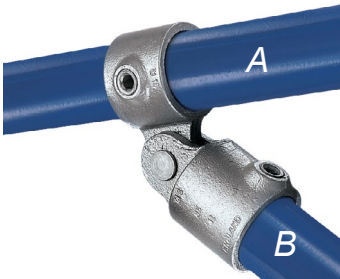

Complete combination fitting. Reducing combinations of Type C50 are available sizes 5 through 9. See Types F50 and M50 for individual fitting specifications. See 'Swivel Fittings' at bottom of page for more information.

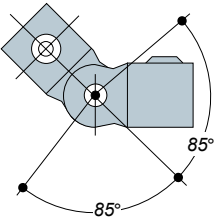

type	pipe reference		weight (lb.)
	A	B	
C50-44	4	4	0.33
C50-55	5	5	1.23
C50-66	6	6	1.41
C50-77	7	7	1.76
C50-88	8	8	2.01
C50-99	9	9	2.69

M50 Male Single Swivel Socket Member

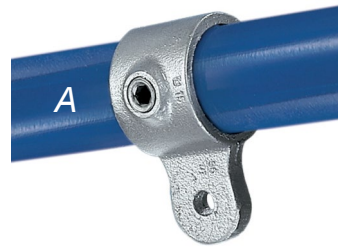

One part of combination fitting C50. This can also be used for attaching flat panels to tubular structures.

Note: Type M50-4 will only mate with a Type F50-4.

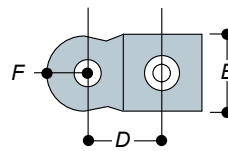

type	pipe ref.	measurements (in.)					weight (lb.)
		A	D	E	F	Ø	
M50-4	4	1.02	0.79	0.43	0.25	0.13	
M50-5	5	1.57	1.57	0.75	0.39	0.53	
M50-6	6	1.69	1.57	0.75	0.39	0.60	
M50-7	7	1.89	1.85	0.75	0.39	0.79	
M50-8	8	2.13	1.85	0.75	0.39	0.92	
M50-9	9	2.44	2.05	0.75	0.39	1.19	

Ø indicates diameter of bolt hole.

MH50 Male Single Horizontal Swivel Socket Member



This fitting can be used for attaching flat panels to tubular structures. Specially designed for retail shelving applications. Can also be used as part of a Type CH50 combination fitting.

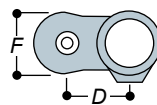

type	pipe ref.	measurements (in.)						wt (lb.)
		A	D	E	F	G	H	
MH50-6	6	1.69	1.42	1.50	0.43	1.81	0.39	0.66

Ø indicates diameter of bolt hole.

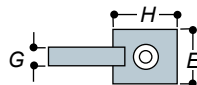

Swivel Fittings

Types F50, M50, MH50, M51, MH51, M52, and M58 are known as swivel fittings and can be assembled as Types C50, CH50, C51, C52, and C58 or supplied as separate items. They are frequently used for bracing but can also overcome problems where joints are required at angles other than those achieved by fixed angle fittings. For economical use of pipe, when making 'C' fittings, or combination fittings, Types F50 (sizes 5-9 only) can be combined with different sizes of Types M50, MH50, M51, MH51, M52, and M58. F50-4 and M50-4 will only combine with each other.

WARNING: An entire structure should not be constructed from swivel fittings, as they would not provide sufficient stability or rigidity in the structure. Types M50, MH50, M51, M52 and M58 can also be used separately to secure various types of in-fill panel. These fittings are not designed to take bending moments.

P50 Modified M50-8 with Offset Slot



Designed for the securing of various types of panels and flooring to pipe structures (ie. plywood, plastic sheeting, wood planking, etc.). This fitting has one offset flange to allow the flush attachment of panels to pipe. Often used with Type P51. See also Type P57.

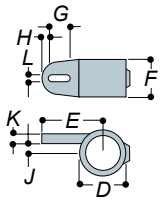

type	pipe		measurements (in.)								wt (lb.)
	A	D	D	E	F	G	H	J	K	L	
P50-8	8	2.40	3.15	1.85	1.26	0.31	0.39	0.43	0.51	1.06	

MH51 Male Double Horizontal Swivel Socket Member

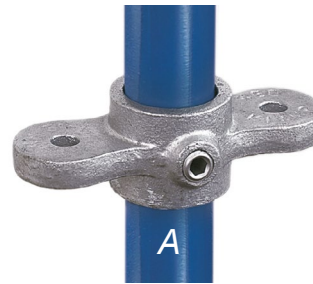

This fitting can be used for attaching flat panels to tubular structures. Specially designed for retail shelving applications, the MH51 can be used as part of a CH51 combination fitting.

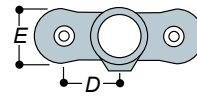

type	pipe		measurements (in.)						wt (lb.)
	A	D	D	E	F	G	H	Ø	
MH51-6	6	1.69	1.50	0.43	1.81	1.50	0.39	0.97	

Ø indicates diameter of bolt hole.

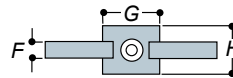

C51 Double Swivel Socket

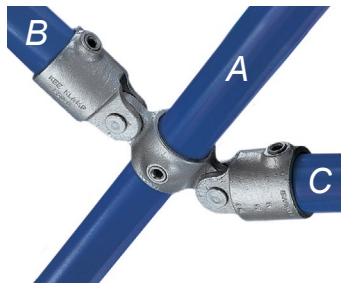

Complete combination fitting. Type C51 is made by combining two Type F50 fittings and one Type M51. For dimensions refer to Type F50 and Type M51. See 'Swivel Fittings' on page 12 for more information.

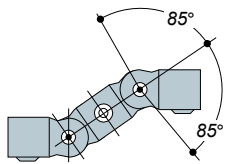

type	pipe reference			weight (lb.)
	A	B	C	
C51-555	5	5	5	2.18
C51-666	6	6	6	2.45
C51-777	7	7	7	2.98
C51-888	8	8	8	3.46
C51-999	9	9	9	4.54

P51 Modified M51-8 with Offset Slots



Designed for the secure fitting of various types of panels and flooring to pipe structures (ie. plywood, plastic sheeting, wood planking, etc.) This fitting has two offset flanges to allow the flush attachment of panels to pipe.

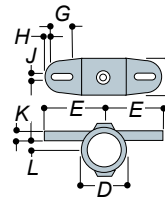

type	pipe		measurements (in.)								wt (lb.)
	A	D	D	E	F	G	H	J	K	L	
P51-8	8	2.40	3.19	1.85	1.26	0.31	0.51	0.43	0.39	1.54	

M51 Male Double Swivel Socket Member

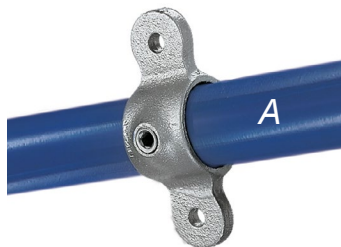

One part of a Type C51 combination fitting. This fitting can also be used for attaching flat panels to tubular structures.

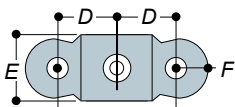

type	pipe ref	measurements (in.)				weight (lb.)
		A	D	E	F	
M51-5	5	1.57	1.57	0.75	0.39	0.73
M51-6	6	1.69	1.57	0.75	0.39	0.84
M51-7	7	1.89	1.85	0.75	0.39	1.01
M51-8	8	2.13	1.85	0.75	0.39	1.06
M51-9	9	2.44	2.05	0.75	0.39	1.57

Ø indicates diameter of bolt hole.

C52 Corner Swivel Socket

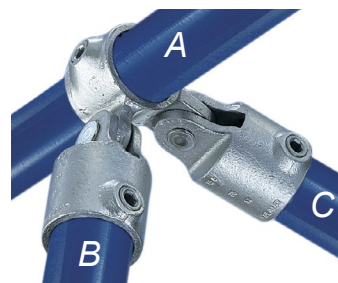

Complete combination fitting. Reducing combinations of Type C52 are available sizes 5 to 8. For dimensions refer to Type F50 and Type M52. See 'Swivel Fittings' on bottom of page 12 for more information.

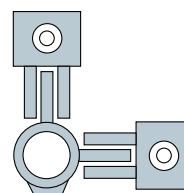

type	pipe reference			weight (lb.)
	A	B	C	
C52-555	5	5	5	2.14
C52-666	6	6	6	2.47
C52-777	7	7	7	2.96
C52-888	8	8	8	3.42

M52 Male Corner Swivel Socket Member

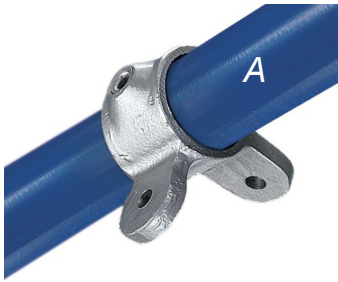

One part of a Type C52 combination fitting. This can also be used for attaching flat panels to tubular structures.

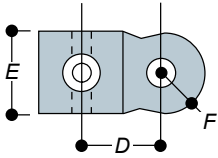

type	pipe ref		measurements (in.)				weight (lb.)
	A		D	E	F	Ø	
M52-5	5		1.57	1.57	0.75	0.39	0.84
M52-6	6		1.69	1.57	0.75	0.39	0.82
M52-7	7		1.89	1.85	0.75	0.39	0.98
M58-8	8		2.13	1.85	0.75	0.39	1.00

Ø indicates diameter of bolt hole.

56 Acute Angle Elbow

Type 56 is an ideal fitting to use as an alternative to bending or when a junction between a sloping pipe and an end post is required, ie. guardrail and staircases (Refer to page 41 for more information).

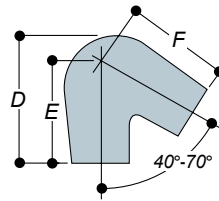
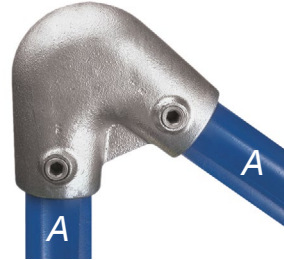

type	pipe reference		measurements (in.)			weight (lb.)
	A		D	E	F	
56-8	8		5.28	4.41	4.41	2.92

BC53 Swivel Elbow

Type BC53-8 fitting has been designed as a variable angle in-line connection, adjustable through 202°.



WARNING: An entire structure should not be constructed from Type BC53-8 or any other swivel fitting, as these types would not provide sufficient stability or rigidity in the structure due to the free rotation of the fitting.

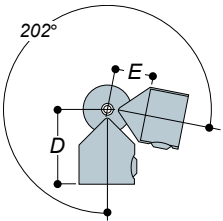

type	pipe reference			measurements (in.)			weight (lb.)
	A	B	C	D	E	F	
BC53-8	8			3.35	1.77		2.48

P57 Modified M50-8 with Slot

Designed for the securing of various types of panels and flooring to pipe structures (ie. plywood, plastic sheeting, wood planking, etc.). This fitting has a single offset flange to allow for the attachment of panels to pipe. See Type P50.

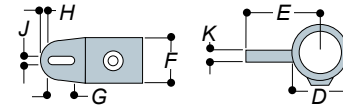
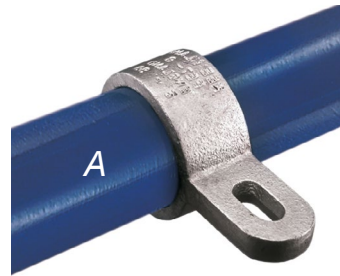

type	pipe	measurements (in.)							weight (lb.)
		A	D	E	F	G	H	J	
P57-7	7	2.15	4.01	1.26	1.00	0.13	0.50	0.43	0.82
P57-8	8	2.40	3.19	1.85	1.26	0.31	0.39	0.43	1.54

55 Obtuse Angle Elbow

The Type 55 is an ideal fitting to use as an alternative to bending, or when a junction between a sloping pipe and an end post is required, ie. guardrail and staircases (Refer to page 41 for more information).

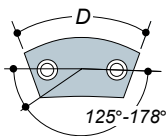

type	pipe reference		measurements (in.)		weight (lb.)
	A		D	E	
55-6	6		1.81	4.57	1.12
55-7	7		2.17	6.06	1.80
55-8	8		2.36	6.02	1.90

C58 Swivel Flange

A swivel fitting for attachment of angled pipe to a flat surface. For dimensions refer to Type F50 and Type M58.

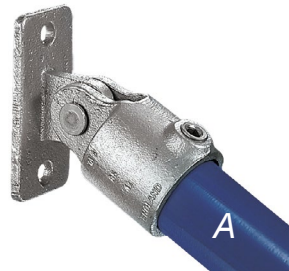

WARNING: C58 is not recommended for use as a base flange to support guardrail, balustrades, or other types of structure.

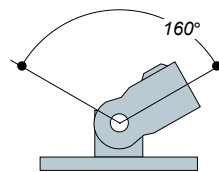

type	pipe reference			measurements (in.)			weight (lb.)
	A	B	C	D	E	F	
C58-5	5						1.54
C58-6	6						1.68
C58-7	7						1.85
C58-8	8						2.07
C58-9	9						2.36

M58 Base Plate



This fitting may be considered for various wall and brace fixings. It is often combined with Type F50 to give the adjustable angle fitting Type C58. The diameter of the attachment bolt hole is 0.39 inch (10mm).

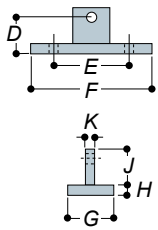

type	measurements (in.)							wt (lb.)	
	D	E	F	G	H	J	K		
M58	1.34	3.27	4.41	2.05	0.24	1.77	0.35	0.47	0.82

Ø indicates diameter of fixing holes.

60 Extra Heavy Flange

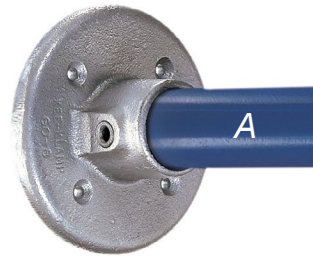

Heavy duty flange with wide base for spreading loads over a large surface area. Hole provided for countersunk flat head screw fixings only, for use on structures where the fixing required is positional only. Frequently used as a wall fixing bracket (refer to table on page 43).

WARNING: It is not recommended for use as a base flange to support guardrail or balustrades (see Type 62).

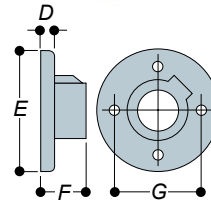

type	pipe A	measurements (in.)					wt (lb.)
		D	E	F	G	Ø	
60-5	5	0.55	5.12	2.52	3.11	0.31	2.54
60-6	6	0.55	5.51	2.52	3.39	0.31	2.54
60-7	7	0.55	5.87	2.52	3.74	0.31	2.87
60-8	8	0.55	6.18	2.52	4.02	0.31	3.26

Ø indicates diameter of fixing holes.

P58 Double Tab Panel with CSH

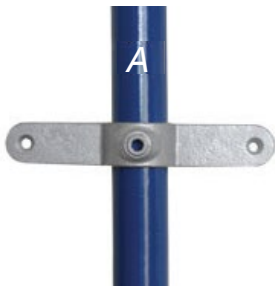

This fitting can be used for attaching flat panels to tubular structures. The drilled holes are countersunk for to suit a flat head screw and bolt fasteners.

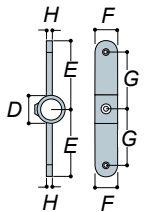

type	pipe ref. A	measurements (in.)						wt. (lb.)
		D	E	F	G	H	Ø	
P58-7	7	2.15	4.06	1.26	3.39	0.43	0.25	1.23

61 Flange

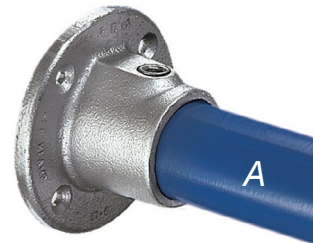

Used on structures where the fixing required is positional only. Frequently used as a wall fixing bracket (refer to table on page 43). Holes provided for countersunk flathead screw fixings only.

WARNING: It is not recommended for use as a base flange to support guardrail or balustrades (see Type 62).

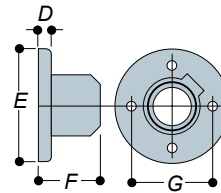

type	pipe A	measurements (in.)					wt (lb.)
		D	E	F	G	Ø	
61-3	3	0.25	2.76	1.26	1.85	0.26	0.42
61-4	4	0.25	3.07	1.54	2.13	0.26	0.51
61-5	5	0.25	3.15	1.57	2.24	0.26	0.73
61-6	6	0.25	3.54	1.93	2.52	0.26	1.10
61-7	7	0.25	4.02	2.01	2.99	0.31	1.37
61-8	8	0.25	4.53	2.32	3.50	0.31	1.48
61-9	9	0.39	5.00	2.48	3.74	0.39	2.38

Ø indicates diameter of fixing holes.

59 Spigot Flange



A spigot flange which fits inside the pipe and is not secured by a set screw. Type 59 can only be used with a pipe wall thickness of 1/8" and in light, self supporting structures.

Note: No fixing holes are provided in this fitting.

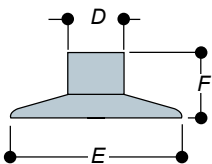

type	pipe ref. A	measurements (in.)			weight (lb.)
		D	E	F	
59-5	5	0.75	3.19	1.10	0.24
59-6	6	1.02	3.43	1.26	0.26
59-7	7	1.30	3.86	1.34	0.44
59-8	8	1.50	4.09	2.05	0.62
59-9	9	2.01	4.37	1.85	0.66

62 Standard Railing Flange



Ideal when a structural fixing is required for guard rail and balustrades. The holes are of sufficient diameter to insure proper fixing with either mechanical or chemical anchor. The two set screws in the vertical socket give greater side-load stability to the upright. It is recommended that the fixing holes in the flange should be in line with the applied load (refer to table on page 43).

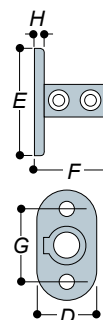

type	pipe A	measurements (in.)						wt (lb.)
		D	E	F	G	H	Ø	
62-2	2	1.26	2.52	1.73	1.54	0.20	0.35	0.09
62-5	5	2.56	4.57	3.11	2.99	0.24	0.43	1.30
62-6	6	2.99	5.04	3.50	3.50	0.31	0.55	1.61
62-7	7	2.99	5.51	3.54	4.02	0.43	0.55	2.87
62-8	8	3.34	6.10	3.50	4.53	0.39	0.55	2.86
62-9	9	4.02	6.50	5.00	5.00	0.39	0.71	3.88

Ø indicates diameter of fixing holes.

63 Angle Base Flange



Similar to Type 62, but used to set up the upright at an angle between 45° to 60°. This fitting should only be subjected to light loads which cannot be positioned at 90° to the applied load. For greater loads or other pipe sizes, a Type 62 flange is used and the upright bent to the required angle (refer to table on page 43).

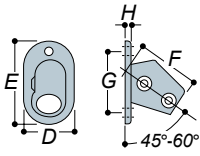

type	pipe A	measurements (in.)							wt (lb.)
		D	E	F	G	H	Ø		
63-6	6	3.07	5.12	3.62	3.78	0.31	0.55	2.16	
63-7	7	2.99	5.43	3.74	4.17	0.39	0.55	2.54	
63-8	8	3.54	6.10	3.94	5.43	0.39	0.55	3.31	

Ø indicates diameter of fixing holes.

66 Ground Socket



A ground socket fitting for setting in concrete. The posts may either be permanent or removable as required. It incorporates a socket set screw fixing and can be supplied with a plug to fill the hole when the pipe is removed (refer to table on page 43).

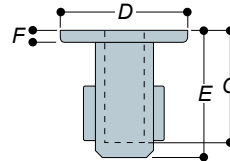

type	pipe ref. A	measurements (in.)					weight (lb.)
		D	E	F	G		
66-6	6	5.00	4.84	0.43	4.53	4.12	
66-7	7	5.51	5.35	0.43	5.00	5.12	
66-8	8	5.51	5.35	0.43	5.00	5.51	

64 Standard Vertical Railing Base



Designed for fixing guardrail and balustrades to walls, parapets, steps, and ramps. The upright cannot drop through the socket. Access to the top fixing hole is restricted by the position of the flange to the barrel. When selecting a hexagon head bolt or similar bolt fixing, the maximum length of the bolt including the head must not exceed 1" (refer to table on page 43).

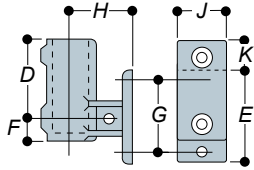

Note: Should an upright be required to pass through the fitting, the base can be bored out to order.

type	pipe A	measurements (in.)								wt (lb.)
		D	E	F	G	H	J	K	Ø	
64-6	6	3.43	3.74	0.83	2.64	2.24	1.77	1.57	0.55	1.70
64-7	7	3.31	4.25	1.18	2.83	2.56	2.01	1.38	0.55	2.47
64-8	8	3.90	4.76	0.87	3.50	2.76	2.20	0.98	0.55	3.40

Ø indicates diameter of fixing holes.

67 Angle Flange

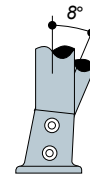

Type 67 has been designed to allow the upright to pivot in the barrel, providing an angular displacement from 3° up to a maximum of 11°, measured from the vertical. Ideal to secure balustrade and guardrail systems on access ramps or other types of slopes (refer to table on page 43).

Note: It is generally recommended that when installing the 67-8 that the fixing holes in the base should be in line with the applied load.

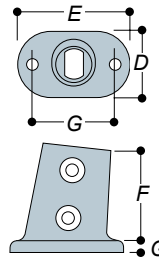

type	pipe A	measurements (in.)						wt (lb.)
		D	E	F	G	H	Ø	
67-8	8	3.78	5.98	3.54	4.49	0.35	0.55	2.87

Ø indicates diameter of fixing holes.

65 Standard Horizontal Railing Base



This fitting is designed for palm fixing guard railing and balustrades to walls, parapets, steps, and ramps. The upright cannot drop through the socket (refer to table on page 43).

Note: Should an upright be required to pass through the fitting, the base can be bored out to order.

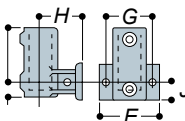

type	pipe A	measurements (in.)							wt (lb.)
		D	E	F	G	H	J	Ø	
65-6	6	3.27	3.86	0.87	2.64	2.24	0.87	0.55	1.68

Ø indicates diameter of fixing holes.

68 Wall Flange

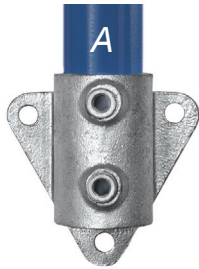

Side fixing for guardrail and balustrades to walls, parapets, steps, and ramps. The upright cannot drop through the socket (refer to table on page 43).

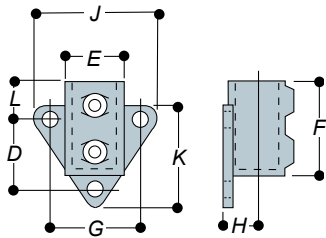

Note: If the upright is required to pass through the fitting by machining out the base stop, the bottom fixing hole will be unusable.

type	pipe A	measurements (in.)									weight (lb.)
		D	E	F	G	H	J	K	L	Ø	
68-6	6	2.48	1.77	3.03	2.80	0.94	3.75	4.06	1.00	0.43	1.37
68-9	7	2.83	2.09	3.27	3.27	1.10	4.19	4.25	1.00	0.43	1.76
68-8	8	3.07	2.36	3.50	3.39	1.22	4.44	4.56	1.00	0.43	2.09

Ø indicates diameter of fixing holes.

69 Railing Flange with Toe Board Adaptor

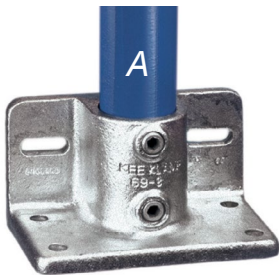

Designed for guardrail and balustrade applications with the added benefit of attaching a toe board to the base. The base plate holes are sufficient diameter to allow for attachment with either a mechanical or chemical anchor. The side plates have slotted holes to allow for a degree of sideways movement for ease of installation. (See page 36 for Toe Board).

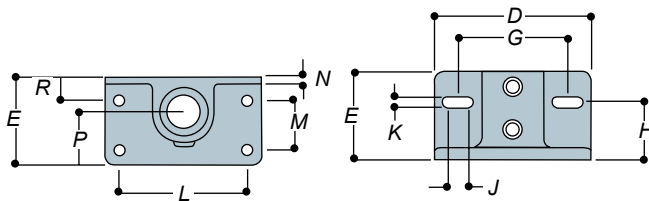

type	pipe A	measurements (in.)						
		D	E	F	G	H	J	K
69-6	6	5.12	2.95	3.07	3.74	2.28	0.59	0.39
69-7	7	5.71	3.15	3.54	3.82	2.28	0.79	0.39
69-8	8	6.30	3.54	3.54	4.41	2.28	0.79	0.39

type	measurements (in.)						weight (lb.)
	L	M	N	P	R	Ø	
69-6	3.94	1.38	0.28	1.77	1.00	0.43	3.79
69-7	4.53	1.57	0.28	1.85	1.00	0.43	4.32
69-8	5.12	1.97	0.28	2.13	1.00	0.43	5.07

Ø indicates diameter of fixing holes.

70 Rail Support

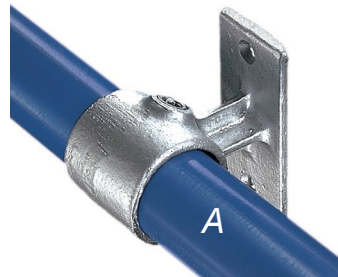

Designed to carry handrails along walls or to fix structures back to walls. The pipe passes through the fitting and cannot be joined with the fitting. Type 70 is also used to attach toe boards to the base of guardrail uprights. Holes provided for countersunk flat head screw fixings only.

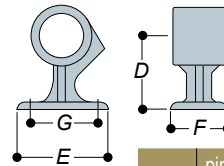

WARNING: Type 70 fittings are not designed to be used as base flanges for full height guardrails or handrails.

type	pipe ref. A	measurements (in.)					wt. (lb.)
		D	E	F	G	Ø	
70-5	5	2.17	3.07	1.81	2.24	0.31	0.79
70-6	6	2.28	3.46	1.57	2.76	0.31	0.97
70-7	7	2.52	4.02	1.81	3.23	0.31	1.23
70-8	8	2.76	4.25	2.05	3.23	0.31	1.72

Ø indicates diameter of fixing holes.

71 Weather Cap



Designed for roof guardrail to ensure a weather-tight seal for base fixing flanges. The weather cap is secured to the upright by means of a combined sealant adhesive.

Note: A separate information sheet detailing fixing instructions is available upon request.

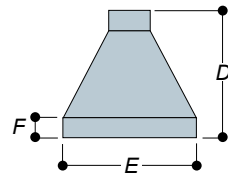

type	pipe reference A	measurements (in.)			weight (lb.)
		D	E	F	
71-6	6	4.92	5.63	0.98	0.53
71-7	7	5.91	6.06	0.98	0.71
71-8	8	6.10	6.57	0.98	0.79

72 Stair Tread Support



Suitable for most types of stair tread, including timber, open steel, and checker plate. Fixing of the tread is by two bolt holes in each fitting. (Special order only.)

WARNING: If Type 72 fittings are to be used for a permanent application or subjected to high loads, the stair tread support pipe which is located at its ends with a single set screw, should be drilled and pinned to avoid rotational slip.

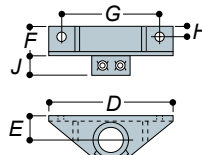

type	pipe A	measurements (in.)						wt (lb.)	
		D	E	F	G	H	J		
72-8	8	7.99	1.54	2.01	5.98	0.75	1.30	0.43	2.76

Ø indicates diameter of fixing holes.

75 Collar



Commonly used to support another fitting if the latter is required to be left untightened, such as gate hinges. Type 75 is also useful when the loading on a structure exceeds the maximum permitted slip load for a set screw, as it gives it additional support.

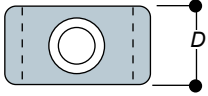

type	pipe reference	measurements (in.)		weight (lb.)
	A	D		
75-4	4	0.91		0.11
75-5	5	1.02		0.29
75-6	6	1.02		0.29
75-7	7	1.02		0.33
75-8	8	1.02		0.42

78 Eye Fitting



Used in conjunction with Type 83 fitting for gate hinges.

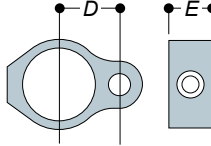

type	pipe reference	measurements (in.)			weight (lb.)
	A	D	E	Ø	
78-5	5	1.18	1.02	0.46	0.46
78-6	6	1.30	1.02	0.55	0.55
78-7	7	1.50	1.02	0.57	0.57
78-8	8	1.61	1.02	0.62	0.62

Ø indicates diameter of pivot hole.

76 Hook



A fitting normally used for attachment of chains.

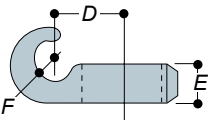

type	pipe reference	measurements (in.)			weight (lb.)
	A	D	E	F	
76-5	5	1.18	1.06	0.35	0.37
76-6	6	1.38	1.06	0.51	0.46
76-7	7	1.50	1.06	0.51	0.51
76-8	8	1.61	1.06	0.51	0.53

79 Sheeting Clip



This fitting is used to attach profiled sheeting material to pipe. The fitting is supplied with the following hardware: one M6x50mm roofing bolt, one M6 square nut, and one M6 lock washer. BZP finish.

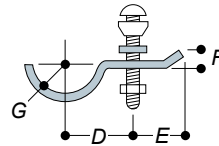

type	pipe	measurements (in.)					wt (lb.)
	A	D	E	F	G	Ø	
79-7	7	1.81	1.34	0.31	0.83	0.31	0.18

Ø indicates diameter of bolt hole.

77 Plastic Plug



Grey plastic plug to fit open ended pipes. See also Type 84.

Note: This fitting can be used with Schedule 40 or 80 pipe only

type	pipe reference	weight (lb.)
	A	
77-4	4	0.002
77-5	5	0.009
77-6	6	0.015
77-7	7	0.035
77-8	8	0.044
77-9	9	0.05

81 Single Sided Clip



For attaching wire mesh in-fill. For economy it is possible to use Type 81 clips without the safety attachment to secure various types of in-fill panels (ply-board, PERSPEX, etc.) up to a thickness of 25/64". All clips are supplied with hexagonal head fixing bolts, M6x35mm long and nut. The primary clip has a slot measuring 0.31 x 0.59 inches.

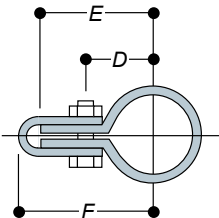

Note: For D and E dimensions the figures are given for the respective minimum and maximum dimensions allowed by the slotted hole.

type	pipe ref	measurements (in.)				weight (lb.)
	A B	D	E	F	Ø	
81-5	5	0.94	1.77	2.20	0.28	0.15
81-6	6	1.06	2.05	2.32	0.28	0.18
81-7	7	1.26	2.24	2.52	0.28	0.18
81-8	8	1.34	2.32	2.60	0.28	0.20
81-9	9	1.57	2.56	2.83	0.28	0.22

Ø indicates diameter of the safety attachment bolt hole.

82 Double Sided Clip

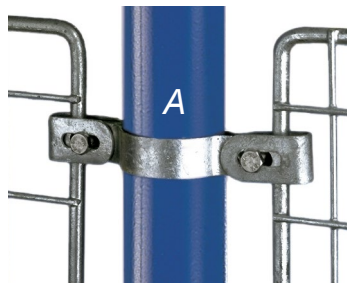

For attaching wire-mesh in-fill. For economy it is possible to use Type 82 clips without the safety attachment, to secure various types of in-fill panels (ply-board, PERSPEX, etc.) up to a thickness of 25/64". All clips are supplied with hexagonal head fixing bolts, M6x35mm long, and nut. The primary clip has a slot measuring 8mm x 15mm.

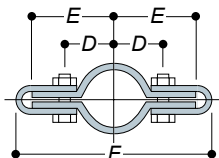

Note: For D and E dimensions the figures are given for the respective minimum and maximum dimensions allowed by the slotted hole.

type	pipe ref. A	measurements (in.)				weight (lb.)
		D	E	F	Ø	
82-5	5	0.94	1.77	4.41	0.28	0.24
82-6	6	1.06	2.05	4.65	0.28	0.26
82-7	7	1.26	2.24	5.04	0.28	0.29
82-8	8	1.34	2.32	5.20	0.28	0.31
82-9	9	1.57	2.56	5.67	0.28	0.31

Ø indicates diameter of the safety attachment bolt hole.

83 Pin Fitting



This fitting is used in conjunction with Type 78 for gate hinges.

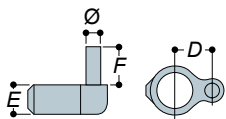

type	pipe ref. A	measurements (in.)				weight (lb.)
		D	E	F	Ø	
83-5	5	1.18	1.02	1.50	0.51	0.44
83-6	6	1.30	1.02	1.50	0.51	0.55
83-7	7	1.50	1.02	1.50	0.51	0.64
83-8	8	1.61	1.02	1.50	0.51	0.66

84 Malleable Plug



A metal drive-in plug which is difficult to remove when installed. For an alternative in plastic, see Type 77.

Note: This fitting can only be used with Schedule 40 steel pipe.

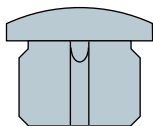

type	pipe reference A	weight (lb.)
84-5	5	0.11
84-6	6	0.22
84-7	7	0.26
84-8	8	0.37
84-9	9	0.64

86 Angle Tee

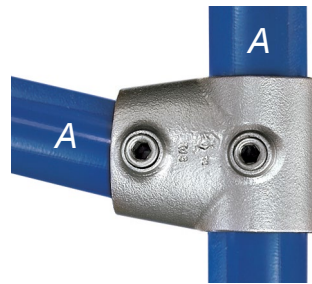

Used to join the middle rail to an upright on a guardrail on a slope from 0° to 11°. Pipe cannot be joined within this fitting.

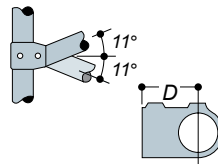

type	pipe ref. A	measurements (in.)	weight (lb.)
		D	
86-7	7	2.36	1.25
86-8	8	2.68	1.68

87 Angle Elbow

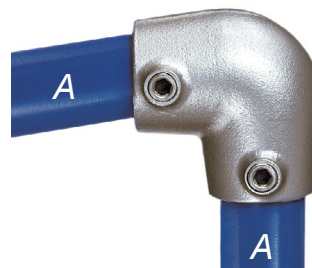

Used to join the top rail to an end upright on a guardrail on a slope from 0° to 11°. Pipe cannot be joined within this fitting.

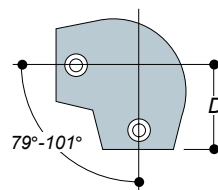

type	pipe reference A	measurements (in.)	weight (lb.)
		D	
87-7	7	2.36	1.80
87-8	8	2.68	1.98

88 Three Socket Angle Tee

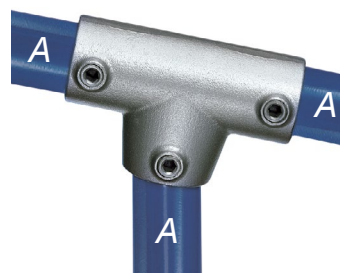

Used to join the top rail to an intermediate upright on a guardrail on a slope from 0° to 11°. As there are two socket set screws in the sleeve, this fitting can be used to join two ends of rail.

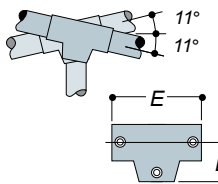

type	pipe reference A	measurements (in.)		weight (lb.)
		D	E	
88-7	7	2.36	5.67	2.16
88-8	8	2.68	6.22	2.73

The Slope Range (86-89)

The slope range of fittings consists of fitting Types 86, 87, 88, 89. These fittings are designed to facilitate in-line railings with vertical posts on slopes with angles between 0 and 11. They can be used to construct railings on access ramps for people with disabilities when used in conjunction with the KEE LITE Type L160 fitting.

89 Two Socket Angle Cross

Used to join the middle rail to an intermediate upright on a guardrail on a slope from 0 to 11. The upright passes through the fitting.

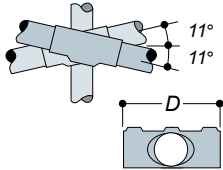
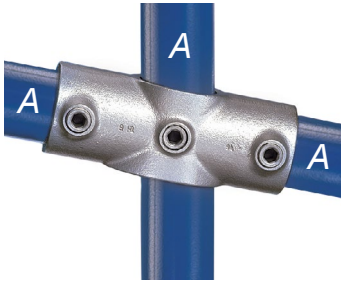

type	pipe reference	measurements (in.)	weight (lb.)
89-7	A 7	D	1.62
89-8	8	6.22	2.05

92 PGR Elbow

Type 92 is used to join the top rail to an end post. (Special order only).

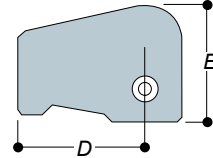
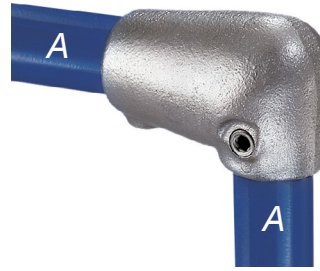

type	pipe reference	measurements (in.)	weight (lb.)
92-8	8	D E	2.84

90 PGR Three Socket Tee

Type 90 is used to join the top rail to an intermediate upright. (Special order only).

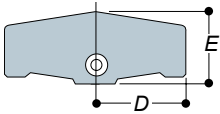

type	pipe reference	measurements (in.)	weight (lb.)
90-8	A B C	D E F	3.90

93 PGR Tee

Type 93 is used to join the mid-rail to an end post. (Special order only).

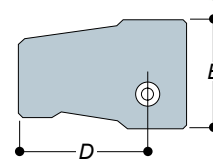
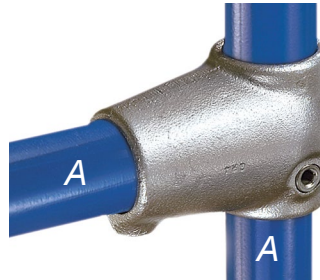

type	pipe reference	measurements (in.)	weight (lb.)
93-8	A	D E	2.65

91 PGR Two Socket Cross

Type 91 is used to join the mid-rail to an intermediate upright. (Special order only).

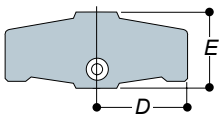
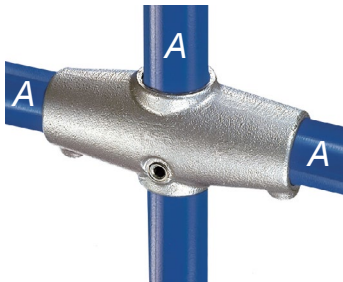

type	pipe reference	measurements (in.)	weight (lb.)
91-8	A	D E	3.97

95 PGR Internal Spigot

Internal spigot designed to prevent sagging of bends when using the 90 to 95 range of fittings. (Special order only).

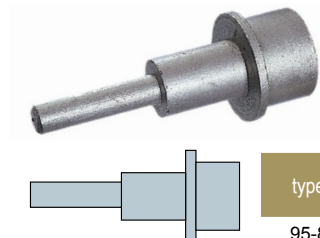

type	pipe reference	weight (lb.)
95-8	A	1.01

The PGR Range (90 to 95)

These are known as Pedestrian Guardrail (PGR) fittings and are used as an alternative to Types 10, 15, 25, and 26 when the site is not straight and level. There is sufficient play within the fitting to negotiate a slope up to 7 feet or a radius greater than 20 feet, when the uprights are at 6-1/2 foot centers, using straight pipe. They also allow damaged rails to be removed without dismantling the adjacent structure.

The 90 to 95 range of fittings is available in size 8. Special order only.

97 Set Screws



Socket set screws are supplied in all KEE KLAMP fittings as standard. KEE KOAT, applied as standard throughout the KEE KLAMP range, provides the set screws with up to four times the corrosion resistance of Bright Zinc Plating.

type	to suit pipe sizes		description
97-2	2	3	5/16" BSF
97-4	4		3/8" BSF
97-6	5	6	ISO 228 G1 1/4"
97-7	7	8 9	ISO 228 G1 3/8"

114 Swivel Tee

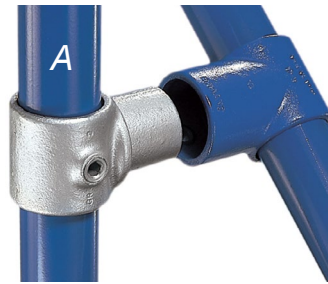

An internal swivel fitting, designed to accommodate varying angles on handrail for staircases, ramps, or bracing. Used in conjunction with Types 10, 15, 25, or 45. Eliminates the need for specially drilled angle fitting Type 27 and 28.

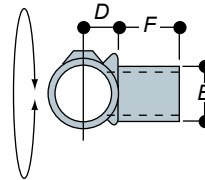

type	pipe ref. A	measurements (in.)			weight (lb.)
		D	E	F	
114-2	2	0.43	0.51	0.83	0.04
114-6	6	0.83	1.34	1.14	0.79
114-7	7	1.02	1.65	1.42	1.19
114-8	8	1.14	1.93	1.61	1.41

100 Plastic Set Screw Cap

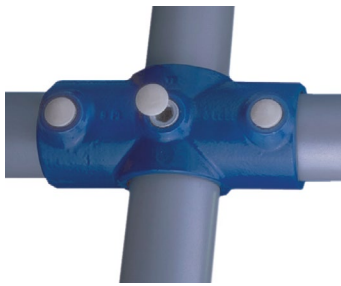

Grey plastic set screw caps provide the perfect finishing touch to galvanized KEE KLAMP fittings. Secure push-in-fit application.

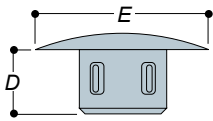

type	pipe reference			measurements (in.)			weight (lb.)
	A	B	C	D	E	F	
100				0.24	0.63		0.00

115 Wall Flange

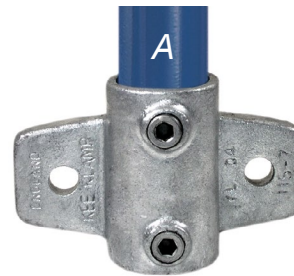

Type 115 is designed for palm fixing of guard rail and balustrades to walls, parapets, steps, and ramps. The upright cannot drop through the socket. Packer plates, Type S115, are available to allow the fitting to be positioned in channels, slots, and other offset areas.

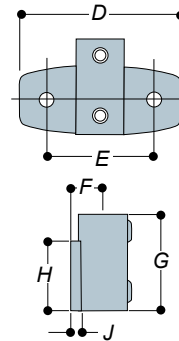

type	pipe A	measurements (in.)							wt (lb.)
		D	E	F	G	H	J	Ø	
115-6	6	5.91	3.94	1.18	3.54	2.56	0.39	0.55	2.34
115-7	7	5.91	3.94	1.38	3.54	2.56	0.39	0.55	2.71
115-8	8	5.91	3.94	1.61	3.54	2.56	0.39	0.55	3.13

Ø indicates diameter of fixing hole.

105 Sheeting Clip without Hardware

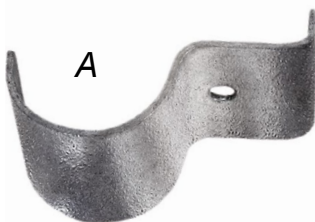

This clip is used to attach profiled or flat sheeting. Not supplied with hardware.

Note: For use where fixing required is positional only. Clip is not intended to bear substantial load.

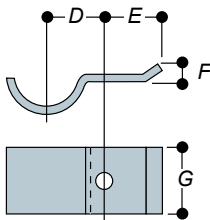

type	pipe A	measurements (in.)					wt (lb.)
		D	E	F	G	Ø	
105-6	6	1.26	1.57	0.51	1.97	0.35	0.31
105-7	7	1.50	1.57	0.51	1.97	0.35	0.35
105-8	8	1.57	1.57	0.51	1.97	0.35	0.40
105-9	9	1.89	1.57	0.51	1.97	0.35	0.51

Ø indicates diameter of bolt hole.

S115 Packer Plate for Type 115



Type S115 allows the Type 115 fitting to be positioned in channels, slots, and other offset areas.

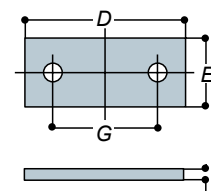

type	measurements (in.)					wt. (lb.)
	D	E	F	G	Ø	
S115	5.90	2.56	0.47	3.94	0.55	1.92

Ø indicates diameter of fixing hole.

118 Cover Flange



This fitting slips over uprights to finish below ground post installations. The fitting is secured to the upright pipe with a single recessed set screw.

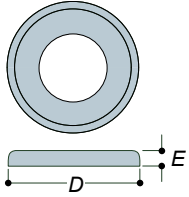

type	pipe ref.	measurements (in.)			weight (lb.)
	A	D	E		
118-8	8	4.00	0.60		0.88

145 Crossover Coupling

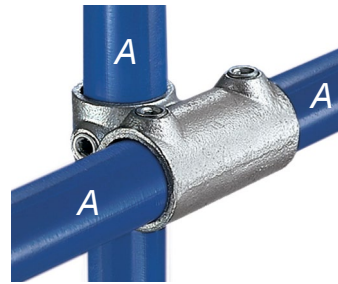

Designed to give a 90° offset crossover. As there are two socket set screws in the sleeve, this KEE KLAMP fitting can be used where a join is required in the horizontal pipe. For economy, it is possible to use a Type 45 in place of the 145, using the 145 only where a join in the pipe occurs. When calculating the cutting lengths for pipe, dimension 'G' should be added to give the pipe length for the upright.

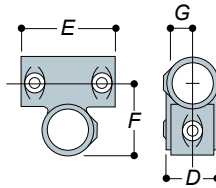

Note: To obtain the true height of the upright the allowance for the base fittings must be included.

type	pipe ref.	measurements (in.)					weight (lb.)
	A	D	E	F	G		
145-7	7	1.81	4.02	1.93	0.91	1.83	

121 Corner Crossover

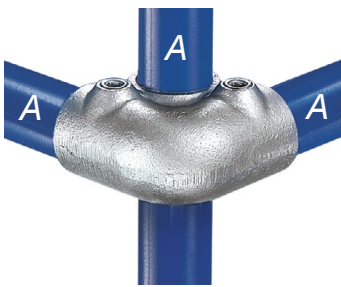

This fitting is designed to provide a 90° offset corner joint. When calculating the cutting lengths for pipe, dimension 'G' should be subtracted to give the pipe length for the rails and dimension 'H' should be added to give the pipe length for the upright.

Note: To obtain the true height of the upright the allowance for the base fittings must be included.

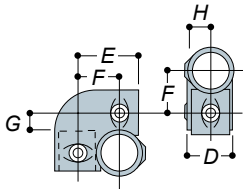

type	pipe ref.	measurements (in.)						wt (lb.)
	A	D	E	F	G	H		
121-7	7	1.81	2.83	1.93	0.87	0.98	2.03	

F151 Gate Fitting



Female member of a gate fitting that mates with a Type 83-7 or 83-8. This gate fitting can be used in conjunction with a spring to create a spring gate. A separate information sheet detailing installation instructions is available upon request. See page 37 for our Safety Spring Gate.

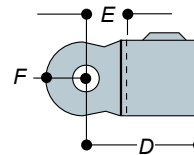

type	pipe ref.	measurements (in.)					wt. (lb.)
	A	D	E	F	Ø		
F151-7	7	2.68	0.98	0.75	0.39	0.93	

Ø indicates diameter of bolt hole.

126 Galvanized Clip



Used to attach shelving and panels to pipe. Curved edge rests under pipe while screw or bolt holds panel in place.

type	pipe reference	measurements (in.)	weight (lb.)
	A	Ø	
126-4	4	0.33	0.03
126-5	5	0.33	0.05
126-6	6	0.38	0.09
126-7	7	0.50	0.12
126-8	8	0.50	0.16
126-9	9	0.50	0.25

262 Round Base Flange



Sleek round base flange. A single fixing hole is hidden to create a more aesthetic look. The two set screws in the vertical socket give greater upright stability.

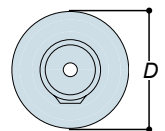

type	pipe ref.	measurements (in.)				wt. (lb.)
	A	D	E	F	Ø	
265-8	8	4.57	3.50	.39	.55	2.12

Ø indicates diameter of fixing hole.

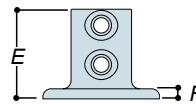

265 Offset Rail Wall Flange



Side fixing for guard rail and balustrades to walls, parapets, steps, and ramps. Upright cannot drop through the socket. Designed for installations of rail that are offset from which it is being fixed.

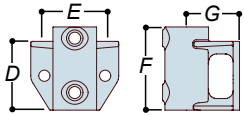

type	pipe ref.	measurements (in.)					wt. (lb.)
	A	D	E	F	G	Ø	
265-7	7	3.39	2.99	4.09	2.60	.55	2.98
265-8	8	3.39	3.55	4.69	2.91	.55	3.48

Ø indicates diameter of fixing hole.

350 Eaves Fitting

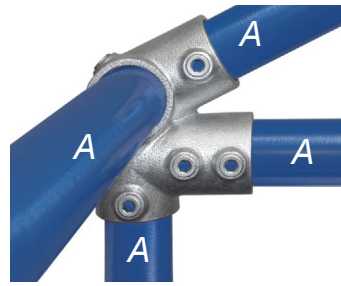

The Type 350 fitting has been designed for small structural building applications and provides for significant load rating. When used with the Type 351 ridge fitting a truss arrangement for additional support can be achieved. Double set screws are provided on the truss outlet to provide additional pull out resistance to hold structures firmly together.

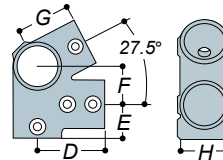

type	pipe ref.	measurements (in.)					wt. (lb.)
	A	D	E	F	G	H	
350-8	8	3.27	1.65	1.85	2.64	2.36	2.62

316 Parapet Flange

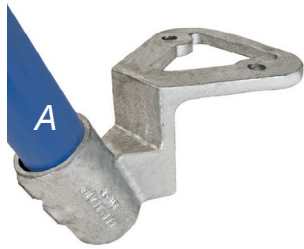

A component designed to retrofit roof parapets that are an unsafe height. Rail anchor is angled 25 degrees from the vertical so that the building's visage is unaffected by the implemented railing. Two holes are located in the top mounting bracket for mounting directly into the parapet. The two set screws in the vertical socket give greater side-load stability to the angled upright. Engineered weep hole allows water to drain.

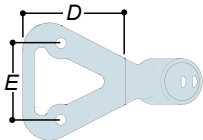

type	pipe ref.	measurements (in.)			weight (lb.)
	A	D	E	Ø	
316-7	7	5.35	4.25	.55	4.21
316-8	8	5.42	4.25	.55	4.52

Ø indicates diameter of fixing hole.

351 Ridge Fitting

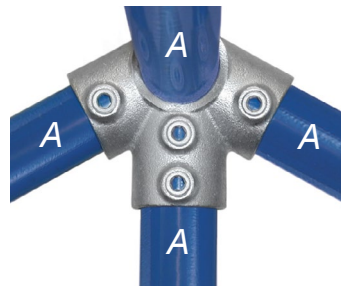

Designed for small structural building applications and provides for significant load rating. When used with the Type 350 eaves fitting a truss arrangement for additional support can be achieved. Double set screws are provided on the downward truss outlet to provide additional pull out resistance and extra strength to the structure.

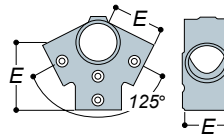

type	pipe ref.	measurements (in.)			weight (lb.)
	A	D	E	F	
351-8	8	3.50	2.64	2.36	2.11





Aluminum Safety Components

KEE LITE components are made from a high grade Aluminum Silicon Magnesium Alloy and provide you with a lightweight, corrosion resistant, and strong alternative for fabrication of pipe structures. The components offer flexibility and can be used for a variety of applications from contemporary to industrial; your imagination is the only limitation.

Because KEE LITE can be easily installed with a hex tool and pipe cutters, there is no need for welding, saving you both time and money. KEE LITE is securely locked into place using recessed set screws that provide a sleek and smooth look to your railing system or pipe structure.

Engineering

KEE LITE offers lightweight and versatile safety solutions. When KEE LITE fittings in sizes 7, 8, 9 are used to construct 42" high guard railing, the railing will meet the requirements of the OSHA design standard of a single 200 lb. load applied at any location along the top rail when the correct specification of pipe is used, and the correct method of design is employed. The integrity of the structure to which the system is secured, and the hardware used will also need to be checked to ensure they are capable of meeting the imposed load requirements (reference OSHA 29 CFR 1910.23). Please contact KEE SAFETY for design assistance.

Fittings by Function

Bases

- L62.....Standard Railing
- L69.....Railing Flange
- L148.....Heavy Duty Rectangular
- L150.....Heavy Duty Four Hole Sq.
- L152.....Four Hole Square

Couplings

- L14.....Straight

Crosses

- L26.....Two Socket
- L30.....30°-45° Adjustable
- L35.....Three Socket

Crossovers

- L45.....Crossover
- L46.....Combination Socket Tee

Elbows

- L15.....90°
- L20.....Side Outlet
- LB54.....Adjustable

Flanges

- LC58.....Swivel
- LM58.....Male Wall Plate
- L61.....Round
- L68.....Wall
- L164.....Offset Wall

Handrail Wall Bracket

- L70.....Rail Support
- L160.....Smooth Handrail Fitting
- L164.....Offset Wall
- 475.....Aluminum Wall Bracket

Plugs

- 77.....Plastic
- L84.....Aluminum

Swivel Sockets

- LC50.....Single Combination
- LF50.....Female Single
- LM50.....Male Single
- LC51.....Double Combination
- LM51.....Male Double
- LC52.....Corner Combination
- LM52.....Male Corner

Tees

- L10.....Single Socket
- L29.....30°-60° Single Socket
- L25.....Three Socket
- L19.....Adjustable Side Outlet
- L21.....90° Side Outlet
- L114.....Swivel
- L46.....Comb. Socket Crossover

Toe Board Kits

- T9901.....Aluminum Toe Board
- T9902.....Upright Hardware Kit

- T9903.....Straight Splice Kit

- T9904.....Corner Splice Kit

Miscellaneous

- 97-S.....Stainless Steel Set Screws
- Gaskets..Neoprene Flange Gaskets

L10 Single Socket Tee

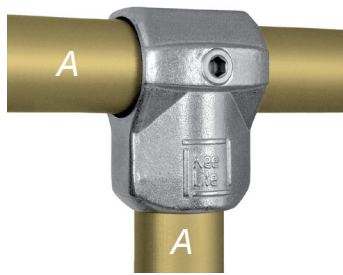

Designed to give a 90° butt joint between two pipes. Frequently used for the joint between end uprights and the middle rail where the railing site is straight and level. Also used for base ties on racking. This fitting cannot be used where the pipe through sleeve 'A' is required to be joined within the fitting.

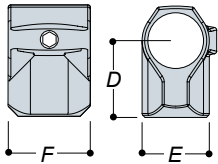

type	pipe ref.	measurements (in.)			weight (lb.)
		A	D	E	
L10-6	6	2.05	1.67	2.20	0.29
L10-7	7	2.56	2.09	2.52	0.44
L10-8	8	2.91	2.36	2.76	0.66
L10-9	9	3.54	2.91	3.23	1.06

L19 Adjustable Side Outlet Tee

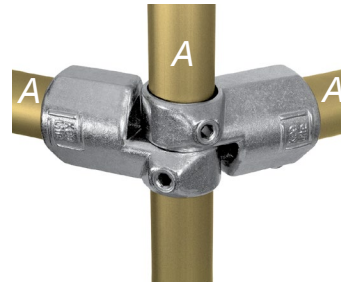

Used to form variable angle joints between 60 and 200°.

Note: Type L19 fittings are bagged in pairs and are weighed, priced, and sold as such.

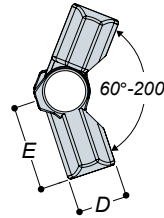

type	pipe ref.	measurements (in.)		weight (lb.)
		A	E	
L19-6	6	1.67	2.95	0.79
L19-7	7	2.09	3.54	1.28
L19-8	8	2.36	3.54	1.46

L14 Straight Coupling

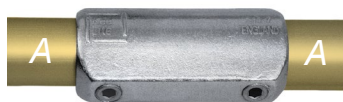

Designed to give an in-line joint between pipes of the same size. Frequently used to enable full pipe lengths to be used in railing applications.

Note: It is not advisable to join the upper and lower rails of a railing within the same bay.

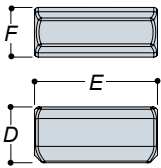

type	pipe ref.	measurements (in.)			weight (lb.)
		A	D	E	
L14-6	6	1.97	3.94	1.67	0.40
L14-7	7	2.32	5.12	2.09	0.73
L14-8	8	2.56	5.83	2.36	0.82

L20 Side Outlet Elbow

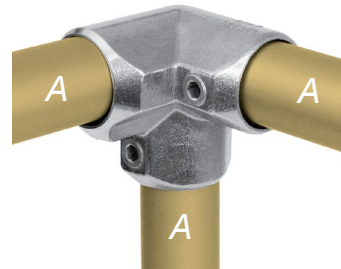

A 90° corner joint most frequently used for the top rail of safety railing. It can also be used for the corner joint of benches, work tables, and other rectangular structures.

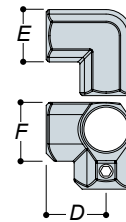

type	pipe reference	measurements (in.)			weight (lb.)
		A	D	E	
L20-6	6	2.05	1.67	1.97	0.42
L20-7	7	2.56	2.09	2.32	0.77
L20-8	8	2.91	2.36	2.56	1.10

L15 90° Elbow

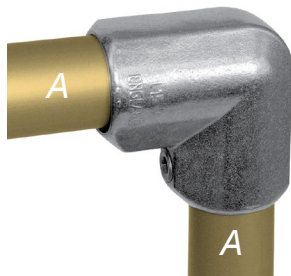

A 90° elbow joint, most frequently used as an end joint for the top rail of safety railing on a level site.

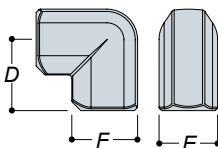

type	pipe reference	measurements (in.)			weight (lb.)
		A	D	E	
L15-6	6	2.05	1.67	2.20	0.31
L15-7	7	2.56	2.09	2.32	0.62
L15-8	8	2.91	2.36	2.56	0.88
L15-9	9	3.54	2.91	3.07	1.46

L21 90° Side Outlet Tee

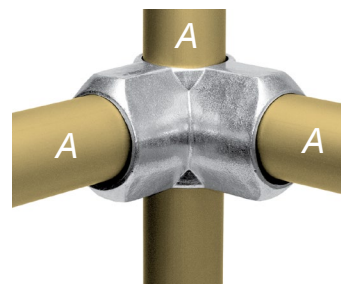

Most frequently paired with type L20 to give a 90° corner joint for the middle rail of safety railing and other rectangular structures. The upright passes through the fitting.

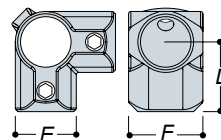

type	pipe reference	measurements (in.)			weight (lb.)
		A	D	E	
L21-6	6	2.05	1.67	2.20	0.35
L21-7	7	2.56	2.09	2.52	0.66
L21-8	8	2.91	2.36	2.76	0.95

L25 Three Socket Tee

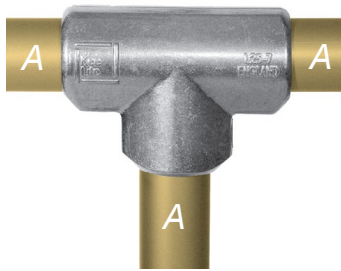

Commonly used as the 90° joint between the top rail and an intermediate upright on safety railing. As there are two socket set screws in the sleeve, this fitting can be used where a join is required in the horizontal pipe. The type L10 fitting can be used as an alternative when a join in the pipe is not required.

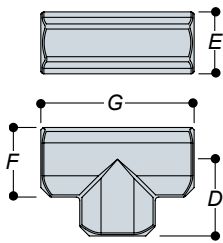

type	pipe ref	measurements (in.)				weight (lb.)
	A	D	E	F	G	
L25-6	6	2.05	1.67	1.97	4.09	0.46
L25-7	7	2.56	2.09	2.32	5.12	0.77
L25-8	8	2.91	2.36	2.56	5.83	1.12
L25-9	9	3.54	2.91	3.07	7.09	1.81

L30 30°-45° Adjustable Cross

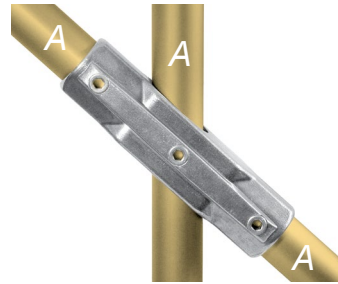

This adjustable fitting can be used for railing on staircases between the mid-rail and intermediate upright which is required to remain vertical. It can be used at any selected angle between 30° and 45°.

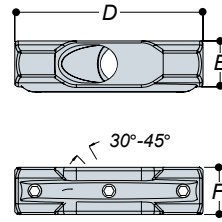

type	pipe reference	measurements (in.)			weight (lb.)
	A	D	E	F	
L30-7	7	8.46	2.07	2.13	1.15
L30-8	8	9.65	2.34	2.36	1.52

L26 Two Socket Cross

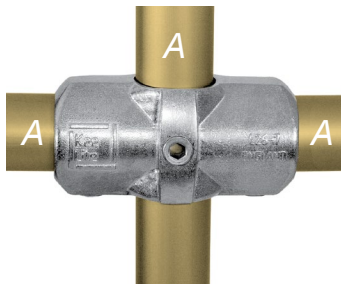

Usually paired with type L25 to give a 90° joint between the middle rail and an intermediate upright on safety railing. The upright passes through the fitting.

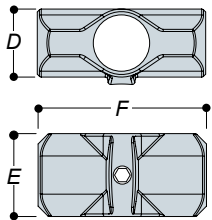

type	pipe reference	measurements (in.)			weight (lb.)
	A	D	E	F	
L26-6	6	1.67	2.20	4.09	0.37
L26-7	7	2.09	2.52	5.12	0.62
L26-8	8	2.36	2.76	5.83	0.99
L26-9	9	2.91	3.23	7.09	1.46

L35 Three Socket Cross

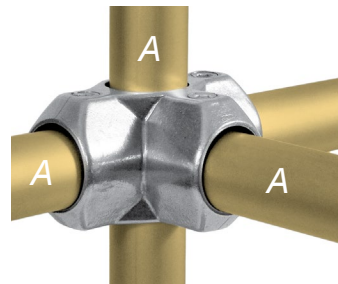

Most frequently used to tie uprights with horizontal pipe in three directions, all 90° to the upright. The upright passes through the fitting.

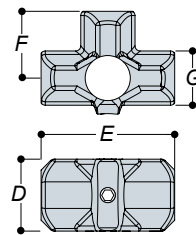

type	pipe ref.	measurements (in.)				weight (lb.)
	A	D	E	F	G	
L35-6	6	2.20	4.09	2.05	1.67	0.68

L29 30°-60° Single Socket Tee

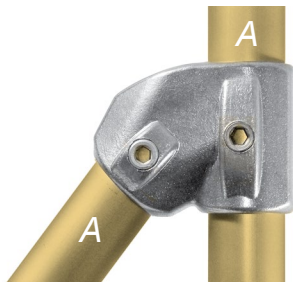

This adjustable fitting is most frequently used for struts and braces. It can be used at any selected angle between 30° and 60°. Suitable for connecting an angled staircase rail to a vertical upright.

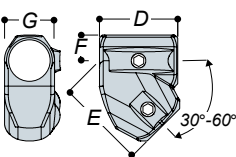

type	pipe	measurements (in.)				weight (lb.)
	A	D	E	F	G	
L29-7	7	3.23	3.74	1.06	2.07	0.70
L29-8	8	3.66	4.25	1.18	2.32	0.90

L45 Crossover

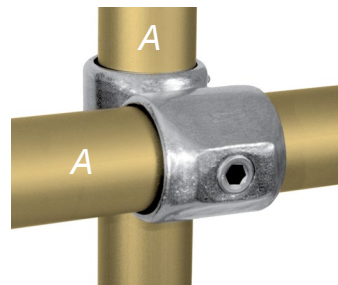

Designed to give a 90° offset crossover joint. Frequently used on safety railing utilizing a continuous horizontal rail, minimizing pipe cuts to reduce costs. Type L45 may also be used to allow intermediate levels on racks.

Note: Pipe cannot be joined with this fitting.

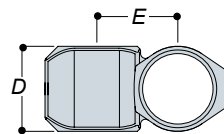

type	pipe reference			measurements (in.)			weight (lb.)
	A	B	C	D	E	F	
L45-6	6			1.73	1.57		0.26
L45-7	7			2.13	1.97		0.68
L45-8	8			2.40	2.20		0.77

L46 Combination Socket Tee and Crossover

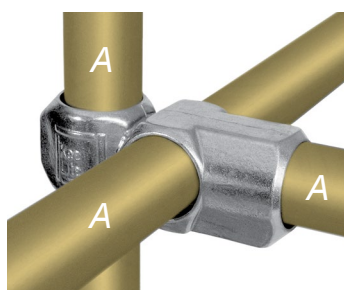

Used on racking to join horizontal carrying rails to the upright, leaving the socket to take a horizontal pipe outside the upright. On pallet racking, it is preferable to have the carrying rails inside the upright.

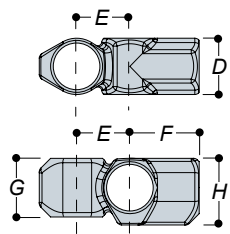

type	pipe ref.	measurements (in.)						wt. (lb.)
		A	D	E	F	G	H	
L46-6	6	1.67	1.57	2.05	1.73	1.97	0.42	

LM50 Male Single Swivel Socket Member

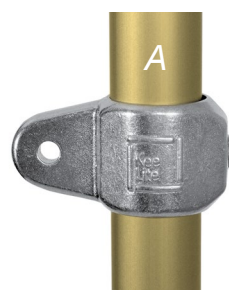

The male portion of a swivel component combination. The fitting can also be used to attach flat panels to tubular structures.

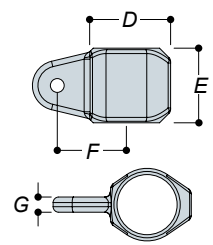

type	pipe A	measurements (in.)					wt. (lb.)
		D	E	F	G	Ø	
LM50-6	6	1.97	1.73	1.85	0.43	0.38	0.26
LM50-7	7	2.32	2.00	1.97	0.43	0.38	1.33
LM50-8	8	2.56	2.36	2.17	0.43	0.38	1.44

LC50 Single Swivel Socket

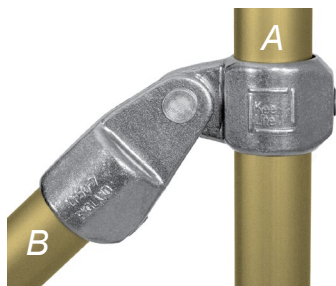

A complete combination swivel fitting, variable through 170°. See Type LM50 and Type LF50 for measurements.

Note: Swivel fittings are not designed to resist bending loads. A structure should not be designed entirely of swivel fittings as they will not provide sufficient stability for the structure.

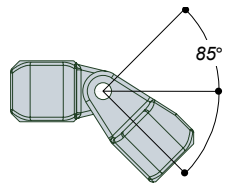

type	pipe reference		weight (lb.)
	A	B	
LC50-66	6	6	0.68
LC50-77	7	7	0.90
LC50-88	8	8	1.10

LC51 Double Swivel Socket

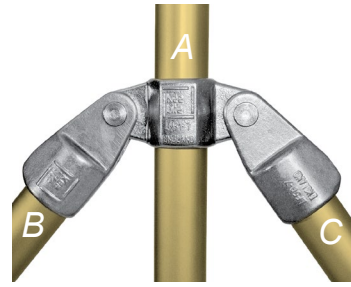

Complete combination fitting. Reducing combinations of type LC51 are available in sizes 6, 7, and 8. See Type LM51 and Type LF50 for measurements.

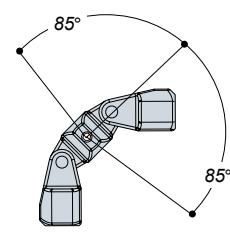

type	pipe reference			weight (lb.)
	A	B	C	
L51-666	6	6	6	1.26
L51-777	7	7	7	1.61
L51-888	8	8	8	1.88

LF50 Female Single Swivel Socket Member



The female part of a swivel component combination.

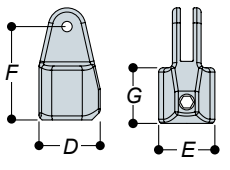

type	pipe A	measurements (in.)				weight (lb.)
		D	E	F	G	
LF50-6	6	1.97	1.67	2.95	0.38	0.37
LF50-7	7	2.32	2.09	3.54	0.38	0.55
LF50-8	8	2.56	2.36	3.54	0.38	0.64

Swivel Fittings

Types LF50, LM50, LM51, LM52, and LM58 are known as swivel fittings and can be assembled as Types LC50, LC51, LC52, and LC58 or supplied as separate items. They are frequently used for bracing but can also overcome problems where joints are required at angles other than those achieved by fixed angle fittings. When making 'C' fittings, or combination fittings, Types LF50 can be combined with different sizes of Type 'M' fittings, or male components. **WARNING: An entire structure should not be constructed from swivel fittings, as they would not provide sufficient stability or rigidity in the structure. Types LM50, LM51, LM52 and LM58 can also be used separately to secure various types of in-fill panel. These fittings are not designed to take bending moments.**

LM51 Male Double Swivel Socket Member

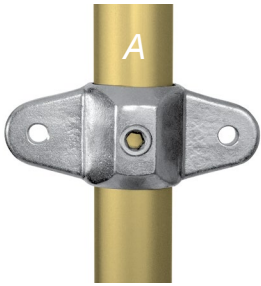

One half of a combination component. This component can also be used for attaching flat panels to tubular structures.

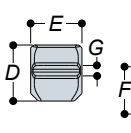

type	pipe		measurements (in.)					wt (lb.)
	A	D	E	F	G	H	Ø	
LM51-6	6	1.97	1.73	1.85	0.43	1.67	0.38	0.35
LM51-7	7	2.32	2.00	1.97	0.43	2.09	0.38	0.51
LM51-8	8	2.56	2.36	2.17	0.43	2.36	0.38	0.60

LB54 Adjustable Elbow

A swivel fitting designed as an in-line variable angle connection, adjustable from 45° to 200°. Nut and bolt included.

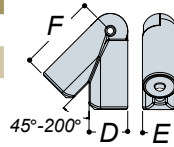
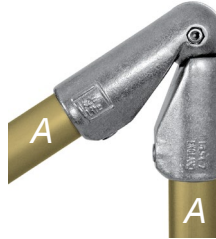

type	pipe ref.		measurements (in.)			weight (lb.)
	A	D	E	F		
LB54-6	6	1.97	1.67	3.94	0.77	
LB54-7	7	2.28	2.17	4.69	1.43	
LB54-8	8	2.56	2.36	5.16	1.61	

LC52 Corner Swivel Socket

Complete combination component. Reducing combinations of type LC52 are available in sizes 6, 7 and 8. See Type LM52 and Type LF50 for measurements.

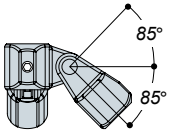
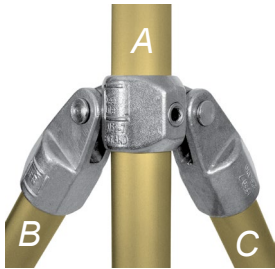

type	pipe reference			weight (lb.)
	A	B	C	
LC52-666	6	6	6	1.06
LC52-777	7	7	7	1.48
LC52-888	8	8	8	1.76

LC58 Swivel Flange

A swivel fitting for attachment of angled pipe to a flat surface. See Type LM58 and Type LF50 for measurements.

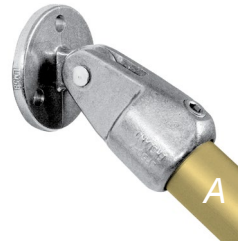

Note: This fitting is not recommended for use as a base flange to support guardrail or balustrades.

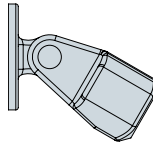

type	pipe reference		measurements (in.)		weight (lb.)
	A	Ø	Ø		
LC58-6	6	0.45	0.74		
LC58-7	7	0.45	1.93		
LC58-8	8	0.45	1.46		

Ø indicates diameter of fixing holes.

LM52 Male Corner Swivel Socket Member

One half of a combination component. This component can also be used for attaching flat panels to tubular structures.

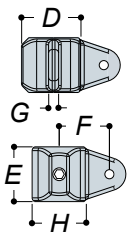
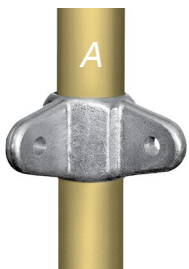

type	pipe ref.		measurements (in.)					wt. (lb.)
	A	D	E	F	G	H	Ø	
LM52-6	6	1.97	1.73	1.85	0.43	1.67	0.38	0.35
LM52-7	7	2.32	2.00	1.97	0.43	2.09	0.38	0.51
LM52-8	8	2.56	2.36	2.17	0.43	2.36	0.38	0.60

Ø indicates diameter of rivet holes.

LM58 Male Wall Plate

The male part of a swivel fitting for attaching angled tubing to flat surfaces.

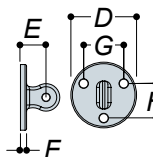
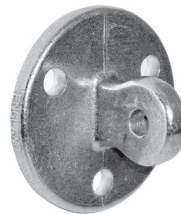

type	measurements (in.)					rivet hole di. (in.)	fixing hole di. (in.)	wt. (lb.)
	D	E	F	G	H			
LM58	3.38	1.32	0.31	2.07	1.78	0.38	0.45	0.37

L61 Flange

This flange, with holes provided for countersunk head fixing screws only, is used in structures where the fixing required is positional only. Frequently used as a wall fixing bracket.

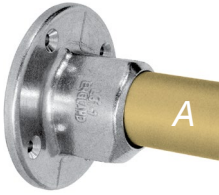

Note: L61 is not recommended for use as a base flange to support guard rail or balustrades. Use Type L152 flange if a base flange is needed.

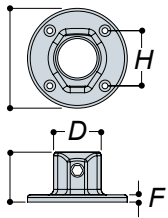

type	pipe ref.	measurements (in.)							wt. (lb.)
		A	D	E	F	G	H	Ø	
L61-6	6	1.67	1.97	0.31	3.94	1.93	0.25	0.46	
L61-7	7	2.09	2.17	0.31	4.33	2.40	0.25	0.64	
L61-8	8	2.36	2.36	0.31	4.72	2.64	0.25	0.71	

Ø indicates diameter of fixing holes.

L68 Wall Flange

Side palm flange for fixing guardrail and balustrades to walls, parapets, steps and ramps. The upright cannot drop through the socket.



Note: If the upright is required to pass through the fitting by machining out the base stop, the bottom fixing hole becomes unusable.

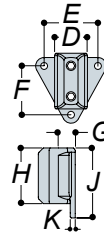

type	pipe	measurements (in.)								wt. (lb.)
		A	D	E	F	G	H	J	K	
L68-6	6	1.67	2.80	2.52	0.95	2.95	3.98	0.31	0.45	0.53
L68-7	7	2.09	3.39	3.15	1.10	3.50	4.45	0.31	0.45	0.77
L68-8	8	2.36	3.78	3.62	1.22	3.94	5.04	0.31	0.45	0.95

Ø indicates diameter of fixing holes.

L62 Standard Railing Flange

The Type L62 flange should always be used to fix down guardrail and balustrades. Holes are of sufficient diameter to give a good fixing with either a mechanical or chemical anchor. Two set screws in the vertical socket give greater stability to the upright. It is recommended that the fixing holes in the flange be in-line with the applied load. The pipe is able to pass through the base of the fitting.

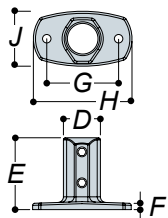
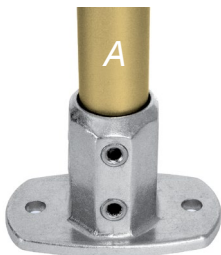

type	pipe	measurements (in.)							wt. (lb.)
		A	D	E	F	G	H	J	
L62-6	6	1.97	3.54	0.35	3.50	5.04	2.95	0.55	0.77
L62-7	7	2.18	3.54	0.35	4.02	5.51	3.23	0.55	0.94
L62-8	8	2.43	3.54	0.35	4.53	6.30	3.31	0.55	0.71

Ø indicates diameter of fixing holes.

L70 Rail Support

This fitting, with holes provided for countersunk flat head screw fixings only, is designed to carry handrails along walls or to fix structures back to walls. The pipe passes through the fitting and cannot be joined within the fitting. Type 70 is also used to attach toe boards to the base of guardrail uprights.

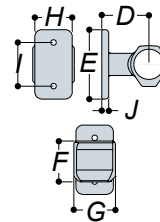
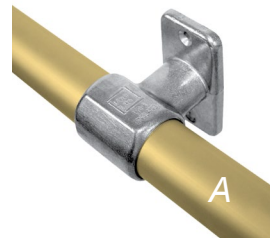

type	pipe	measurements (in.)								wt. (lb.)
		A	D	E	F	G	H	I	J	
L70-6	6	2.36	3.62	1.97	1.97	1.77	2.68	0.39	0.31	0.44
L70-7	7	2.68	4.13	2.32	2.36	2.13	3.19	0.39	0.31	0.75
L70-8	8	2.95	4.53	2.56	2.60	2.36	3.58	0.39	0.31	0.99

Ø indicates diameter of fixing holes.

L69 Railing Flange with Toe Board Adapter

The L69 railing flange has been designed for guard rail and balustrades and allows attachment of a toe board to the base. The base plate holes are of sufficient diameter to allow for attachment with either a mechanical or chemical anchor, the side plates have slotted holes to allow for a degree of sideways movement for ease of installation. A toe board designed for used with Type L69 railing flange is available from KEE SAFETY. (See page 36.)

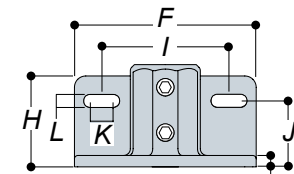
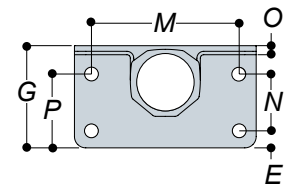
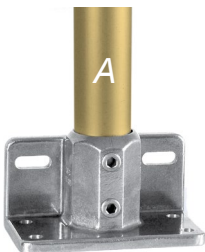

type	pipe ref.	measurements (in.)														weight (lb.)
		A	D	E	F	G	H	I	J	K	L	M	N	O	P	
L69-7	7	0.39	0.59	5.71	3.15	3.15	3.78	2.28	0.79	0.45	4.53	1.57	0.31	2.16	0.45	1.41
L69-8	8	0.39	0.59	6.30	3.54	3.15	4.41	2.28	0.79	0.45	5.12	1.97	0.31	2.24	0.45	1.65

Ø indicates diameter of fixing holes.

L84 Aluminum Plug

A metal drive-in plug. For proper insertion, a rubber mallet should be used. The metal plug is difficult to remove once installed.

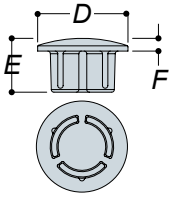

type	pipe ref.	measurements (in.)			weight (lb.)
	A	D	E	F	
L84-6	6	1.34	1.20	0.22	0.04
L84-7	7	1.69	1.22	0.24	0.11
L84-8	8	1.93	1.22	0.24	0.11

L148 Heavy Duty Rectangular Flange

Type L148 is a structural base fixing used to fix down guardrail and balustrades. This fitting is available with either two or four fixing holes which are sufficient diameter to give a good fixing with either a mechanical or chemical anchor. The two socket set screws give greater stability to the upright. It is recommended that fixing holes be in-line with the applied load.

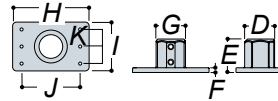
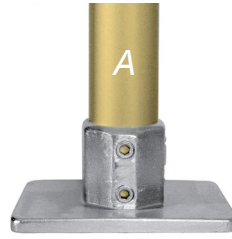

type	pipe	measurements (in.)									wt (lb.)
	A	D	E	F	G	H	I	J	K	Ø	
L148-9/2	9	1.97	3.54	0.35	3.50	5.04	-	-	2.95	0.55	0.77
L148-9/4	9	2.18	3.54	0.35	4.02	5.51	-	-	3.23	0.55	0.94

Ø indicates diameter of fixing holes.

97-S Stainless Steel Set Screws

For highly corrosive environments, stainless steel set screws are available at a small additional charge. Available for sizes 7, 8, and 9.



L150 Heavy Duty Four Hole Square Flange

A heavy duty, four point fixing base flange. Ideal when a structural fixing is required.

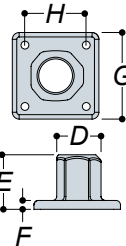

type	pipe ref.	measurements (in.)						wt (lb.)
	A	D	E	F	G	H	Ø	
L150-8	8	2.56	3.00	0.51	5.00	3.50	0.45	1.61

Ø indicates diameter of fixing holes.

L114 Swivel Tee

An internal swivel fitting designed to accommodate varying angles on handrail to staircases, ramps, or bracing. Used in conjunction with types L10, L15, L25, or L45, it eliminates the need for specialty drilled angle fittings.

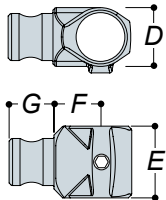
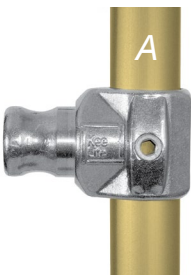

type	pipe ref.	measurements (in.)				weight (lb.)
	A	D	E	F	G	
L114-6	6	1.97	2.20	1.77	1.26	0.40
L114-7	7	2.09	2.52	1.69	1.57	0.64
L114-8	8	2.36	2.76	1.81	1.57	0.78

L152 4 Hole Square Flange

A four point fixing base or wall flange.

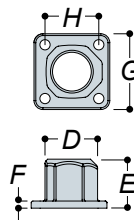

type	pipe ref.	measurements (in.)						wt (lb.)
	A	D	E	F	G	H	Ø	
L152-6	6	1.97	1.81	0.25	2.99	2.06	0.31	0.35
L152-7	7	2.32	2.17	0.31	3.35	2.38	0.45	0.59
L152-8	8	2.56	2.56	0.31	3.62	2.63	0.45	0.68

Ø indicates diameter of fixing holes.

L160 Smooth Handrail Fitting

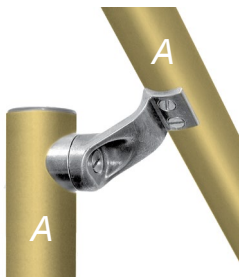

Designed to provide attachment for a smooth handrail which complies with the Americans with Disabilities Act of 1990. The fitting swivels during installation, allowing the handrail to be placed at any angle. The fitting is supplied as a kit including fasteners.

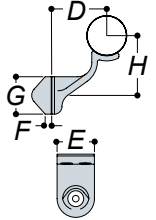

type	pipe ref.	measurements (in.)						wt. (lb.)
		D	E	F	G	H		
L160-7	7	2.32	1.57	0.39	1.57	2.52	0.24	
L160-8	8	2.32	1.57	0.31	1.57	2.64	0.22	

Neoprene Gaskets



Gaskets are available to prevent the corrosion associated with lime in concrete. The gaskets have more resistance than natural rubber to sunlight, ozone, and oxidation. Neoprene is heat resistant and does not soften as natural rubber does under severe exposure. Gasket part numbers correspond to KEE LITE flange and base components as follows:

LG58					LG70-6		
	LG61-7	LG62-7	LG68-7	LG69-7	LG70-7		LG152-7
	LG61-8	LG62-8	LG68-8	LG69-8	LG70-8	LG150-8	LG152-8

L164 Offset Wall Flange

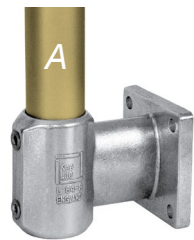

This component is designed for palm fixing of uprights to steel channels, walls, parapets, steps, and ramps. The upright cannot drop through the socket.

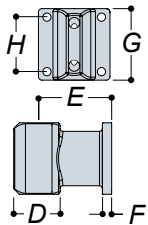

type	pipe ref.	measurements (in.)						wt. (lb.)
		D	E	F	G	H	Ø	
L164-8	8	2.56	4.00	0.50	4.00	3.00	0.45	1.87

Ø indicates diameter of fixing holes.

475 Aluminum Wall Bracket



Designed to provide attachment for a smooth handrail which complies with the Americans with Disabilities Act of 1990. Three fixing holes are drilled and countersunk to suit 1/4 in. diameter flat head wood screws. Designed for use with size 7 pipe.

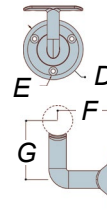

type	pipe	measurements (in.)				pipe wall		wt. (lb.)
		D	E	F	G	Ø	Ø	
475-40	7	3.5	0.25	3.15	3.27	.20	.27	0.57

Ø indicates diameter of fixing holes in inches.





ADA Components

KEE SAFETY has developed the KEE ACCESS Railing System specifically to equip architects, engineers, specifiers, builders, and contractors with the components necessary to easily construct and retrofit commercial and public structures to satisfy the requirements of the Americans with Disabilities Act (ADA), as well as state and local building codes. KEE ACCESS components were designed for constructing of smooth handrail gripping surfaces using standard 1-1/4" schedule 40 pipe. The KEE ACCESS Railing System is a cost effective ADA handrail solution suitable for stairs, ramps, or walkways. An ADA handrail is a framework of horizontal rails supported by vertical uprights, or posts.

Engineering

The modular KEE ACCESS components securely join standard sizes of schedule 40 galvanized steel pipe. Any KEE ACCESS Railing System can be easily installed with a hex tool and pipe cutters, and therefore easily assembled without specialized workers or equipment, saving you both time and money. Components, including schedule 40 pipe, are galvanized, for low long-term maintenance and can be powder coated to your choice of RAL Colors.

KEE SAFETY has a solution for every environment and situation. KEE KLAMP components can be implemented alongside KEE ACCESS components to create a complete line of complementary galvanized components. Send us your drawings, sketches, or layout for a complete detailed proposal.

Fittings by Function

Coupling

514-7.....Internal

Elbows

515-7.....90 Split
520-7.....90 Solid
554-7.....Variable Angle
565-7.....Wall Mounted End Return
567-7.....End Post Handrail Return

Bases + Flanges

561-7.....Wall
565-7.....Wall Mounted End Return

Handrail Wall Bracket

475-40...Aluminum Mounted
518-7.....Galvanized Inset
570-7.....Galvanized Mounted

Tees/Sockets

A10-748..Add-on Single Handrail
1-1/4"
10-840C..Single Handrail Capped
10-848...Single Handrail
A10-848..Add-on Split Single
Handrail 1-1/2"
26-840...Twin Handrail
26-840C..Twin Handrail Capped
555-8.....Top Fix Rail Assembly

Miscellaneous

84-848...Upright Top Cap
508-7.....Gap Washer

KEE ACCESS Basic Assembly

How these components work together to give you the most durable and flexible ADA compliant railing system available.

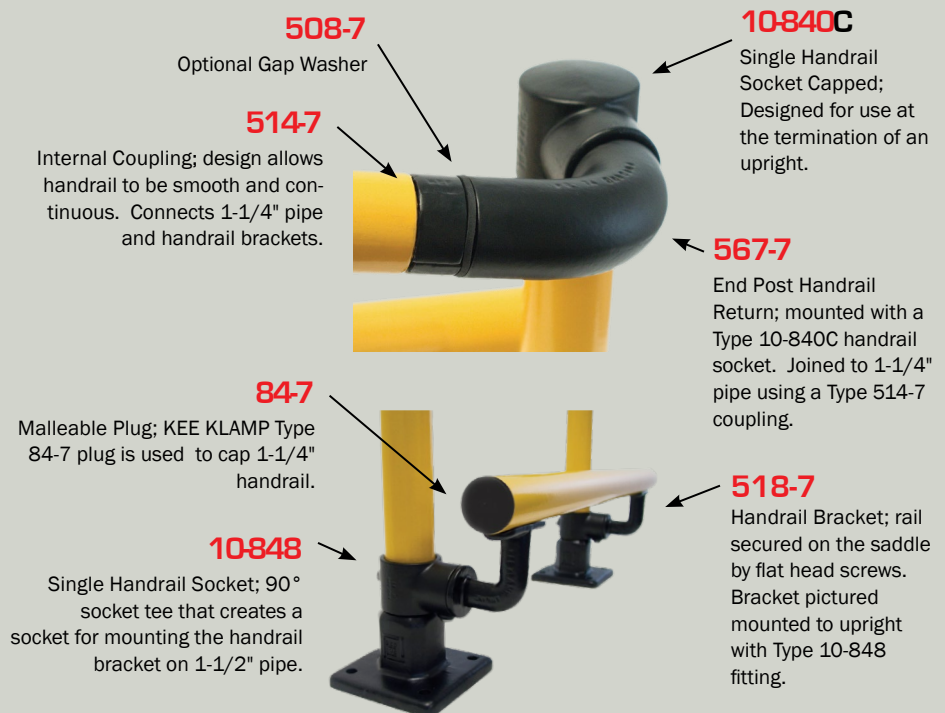

A10-748 Add-on Single Handrail Socket 1-1/4"

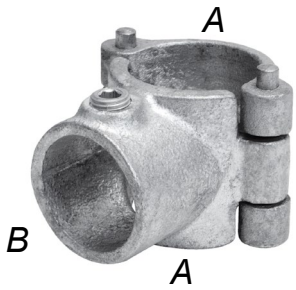

The unique "hinge and pin" system of this socket tee enables existing structures to be easily modified without the need for dismantling. Hinges around existing size 7, or 1-1/4" pipe.

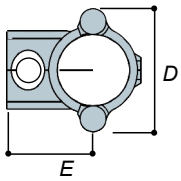

type	pipe ref.		measurements (in.)		weight (lb.)
	A	B	D	E	
A10-748	7	stub	2.99	2.09	0.62

A10-848 Add-on Single Handrail Socket

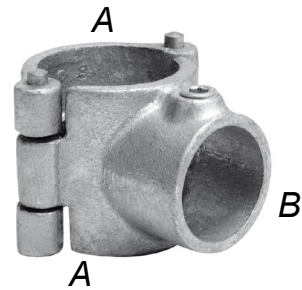

The unique "hinge and pin" system of this socket tee enables existing structures to be easily modified without the need for dismantling. Hinges around existing size 8, or 1-1/2" pipe.

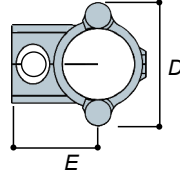

type	pipe ref.		meas. (in.)		weight (lb.)
	A	B	D	E	
A10-848	8	stub	3.23	2.17	0.66

10-840C Single Handrail Socket Capped

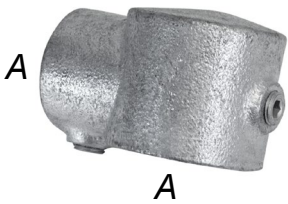

Capped 90° socket tee designed for use at the termination of an upright where a handrail socket needs to be joined.

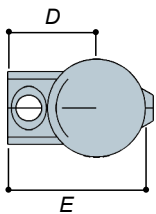

type	pipe ref.		measurements (in.)		wt. (lb.)
	A	B	D	E	
10-840C	8	stub	2.17	3.35	0.90

26-840 Twin Handrail Socket

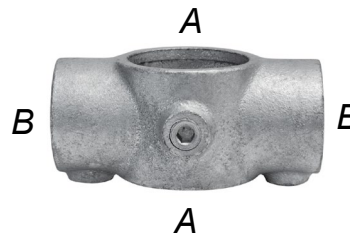

Fitting slips over upright to create to handrail sockets at 90° joints.

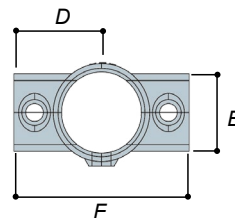

type	pipe ref.		measurements (in.)			weight (lb.)
	A	B	D	E	F	
26-840	8	stub	2.17	1.89	4.33	0.97

10-848 Single Handrail Socket

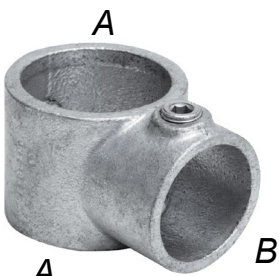

New A 90° elbow joint, most frequently used as an end joint for the top rail of safety railing on a level site.

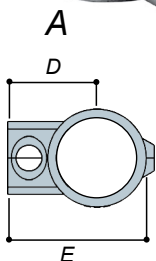

type	pipe ref.		measurements (in.)		weight (lb.)
	A	B	D	E	
10-848	8	stub	2.17	3.35	0.84

26-840C Twin Handrail Socket Capped

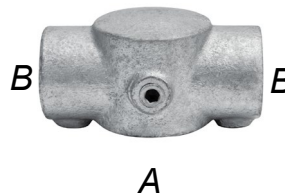

Capped fitting for use at the termination of an upright to create two handrail sockets at 90° joints from the upright.

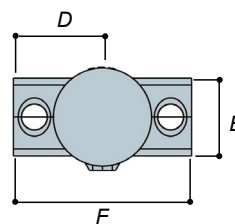

type	pipe ref.		measurements (in.)			wt. (lb.)
	A	B	D	E	F	
26-840C	8	stub	2.17	1.89	4.33	1.10

84-848 Upright Top Cap

A metal drive-in plug which is difficult to remove when installed. The 84-848 is a cap for the open ends of size 8 uprights and covers the top of a 10-848 tee fitting. KEE KLAMP Types 77-7, 77-8, 84-7, or 84-8 could also be used, but do only cap the pipe, not the pipe as well as the component. This fitting can only be used with Schedule 40 steel pipe.

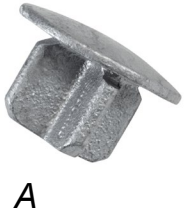

515-7 90 Split Elbow

A 90° corner elbow consisting of two separate pieces, 515-7T and 515-7B, which are joined by a centrally positioned screw. The combined fitting is positioned with the ends inside the adjoining handrails, and the outer grub-screws tightened. This forces the halves apart, gripping the inside of the tube. The central is then tightened, locking the fitting in place.



475 Aluminum Wall Bracket

Designed to provide attachment for a smooth handrail which complies with the Americans with Disabilities Act of 1990. Three fixing holes are drilled and countersunk to suit 1/4 in. diameter flat head wood screws. Designed for use with size 7 pipe.

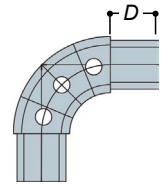

type	pipe ref.	measurements (in.)		weight (lb.)
		D	A	
515-7B	7	1.34	0.93	
515-7T	7	1.34	1.04	

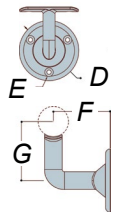

type	pipe	measurements (in.)				pipe Ø	wall Ø	wt. (lb.)
		D	E	F	G			
475-40	7	3.5	0.25	3.15	3.27	.20	.27	0.57

Ø indicates diameter of fixing holes in inches.

518-7 Handrail Bracket

An intermediate upright handrail support. This bracket is designed to be mounted on a Type 10-848 or a Type A10 fitting; the rail sits on the saddle and is secured by either Ø4.8mm x 15mm long aluminum 'multi-grip' pop rivets or No. 10 x 20mm countersunk self-tapping screws.

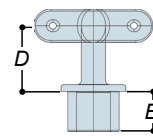
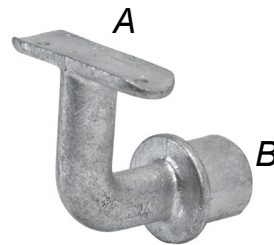

type	pipe ref.		measurements (in.)			wt. (lb.)
	A	B	D	E	Ø	
518-7	7	socket	2.01	1.18	.20	1.08

Ø indicates diameter of rivet holes.

508-7 Optional Gap Washer

A rubber gasket for use with size 7 components. Comes only in black.



514-7 Internal Coupling

Designed especially for ADA railing, this internal coupling can be powder coated unlike our Type 18 fitting. The inset hex screw and precise coupling design allows handrail to be smooth and continuous. This coupling serves as an intermediate handrail support. The internal coupling is a necessary component when installing Type 520-7, Type 554-7, Type 565-7, and Type 567-7.



520-7 90 Solid Elbow

An alternative elbow to Type 515, a two piece fitting. The elbow is designed to be joined to the handrails using two Type 514-7 internal couplings.

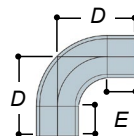
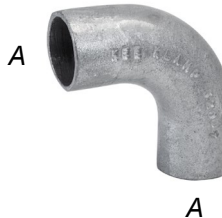

type	pipe ref.	measurements (in.)		weight (lb.)
		D	E	
514-7	7	2.93	1.00	.84

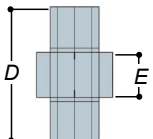

type	pipe ref.	measurements (in.)		weight (lb.)
		D	E	
520-7	514-7	3.15	1.18	0.88

554-7 Variable Angle

A variable angle elbow for changes in elevation. This elbow allow for flexibility within particular designs or plans. The elbow is joined to rails using two Type 514-7 internal couplings.

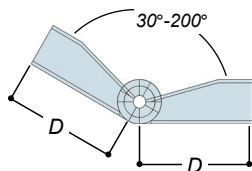
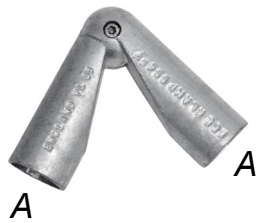

type	pipe ref.	measurements (in.)	weight (lb.)
554-7	A 514-7	D 4.27	.73

565-7 Wall Mounted End Return

A wall mounted handrail return bracket. Bracket is joined to handrail using Type 514-7 coupling. Three fixing holes are drilled and countersunk to suit 1/4 in. diameter flat head wood screws.

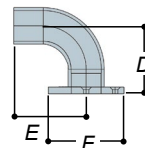

type	pipe ref.	measurements (in.)			weight (lb.)	
565-7	A 514-7	D 3.32	E 3.39	F 3.54	∅ .27	1.48

∅ indicates diameter of fixing holes.

555-8 Top Fix Rail Assembly

Is an in-line, adjustable angle, single top-rail mounted component for use where a guidance handrail is required and where there is no need for a twin-rail guardrail style system. Saddle has a variable angle of 60 from the vertical.

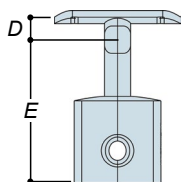

type	pipe ref.		measurements (in.)			weight (lb.)
555-8	A 8	B 7	D .51	E 3.50	∅ .20	1.10

∅ indicates diameter of rivet holes.

567-7 End Post Handrail Return

A handrail return bracket for use when mounting railing to an upright. This handrail is mounted to an upright using a handrail socket. Join the return handrail using Type 514-7 internal coupling.

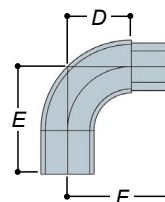

type	pipe ref.		measurements (in.)			weight (lb.)
567-7	A 514-7	B handrail socket	D 2.01	E 3.39	F 3.19	1.08

561-7 Wall Mounted End Return

A wall mounted hand rail end flange. Four fixing holes are drilled and countersunk to suit 1/4 in. diameter flat head wood screws.

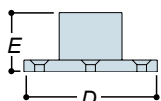
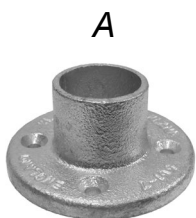

type	pipe ref.	measurements (in.)			weight (lb.)
561-7	7	D 3.54	E 1.57	∅ .27	.77

∅ indicates diameter of fixing holes.

570-7 Wall Mounted Handrail Bracket

A wall mounted version of the 518-7. The handrail tube sits on the 'saddle' and is secured using either No. 12 self-drilling screws or multi-grip pop rivets. This bracket provides holes for countersunk head fixing screws only. Three fixing holes are drilled and countersunk to suit 1/4 in. diameter flat head wood screws.

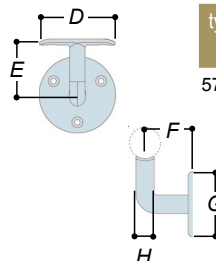
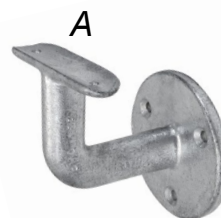

type	pipe ref.	measurements (in.)					wt. (lb.)	
570-7	7	D 3.46	E 2.48	F 3.23	G 3.54	H .98	∅ .27	1.48

∅ indicates diameter of fixing holes.



12585 Fold up Hex Key Set

A rugged set in a handy fold up pocket size.

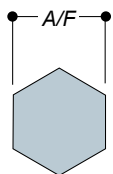

type	to suit pipe sizes	A/F
12585	2 3	5/32"
	4	3/16"
	5 6	7/32"
	7 8 9	1/4"
		5/16"
		3/8"

A/F refers to the dimension across the flats.

98 Ratchet

Ratchet tool complete with 2 hexagonal bits, one 1/4" and one 5/16". Handle is 10" long and has a 1/2" drive. Benefits: easier to fasten set screws and improved design.

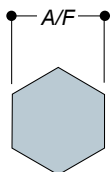

type	to suit pipe sizes	A/F
98	4 5 6	1/4"
	7 8 9	5/16"

A/F refers to the dimension across the flats.

99 Hex Key

Simple hex key. A/F refers to the dimension across the flats.

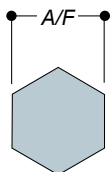

type	to suit pipe sizes	A/F
99-2	2 3	5/32"
99-4	4	3/16"
99-6	5 6	1/4"
99-7	7 8 9	5/16"

A/F refers to the dimension across the flats.

T9901 Toe Board

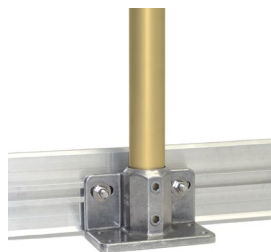

Used with fitting type L69 Railing Flange, the option meets OSHA requirements for toe boards. The toe board is 4" high and is made of aluminum. A channel in the toe board accepts the bolt head of the mounting hardware allowing ease in placement. Toe board is sold by the linear foot. Mounting hardware available separately. Toe board comes in 24' lengths or custom cut.

type	description
T9901	Aluminum Toe Board (4" Wide up to 24' in length)
T9902	Upright Hardware Kit
T9903	Straight Splice Kit
T9904	Corner Splice Kit
T9905	U-Bracket Kit

LSG Safety Spring Gate



Our safety gate has spring hinges and 180° rotation. Installs with simple hand tools to existing uprights. All mounting hardware is included. Available in Hot Dipped Galvanized steel. May be powder coated. All gates have adjustable opening widths minus (-) 1-1/4" and plus (+) 1-1/2" from opening width below..

type	gate to suit opening width of
LSG-18-GALV	18"
LSG-24-GALV	24"
LSG-30-GALV	30"
LSG-36-GALV	36"

In-fill Panels



Panels in a variety of materials, sizes, and finishes. The standard 4" x 4" is available in sizes up to 4' wide by 8' long. Smaller openings available (2" x 2" or 1" x 1"). Material can be provided with a galvanized or powder coat finish, or in bare stainless steel. Virtually any custom configuration is available.

Grip Tape



Improve grip of existing handrail. Made of well-wearing foam. Grip Tape is applied to pipe like a simple sticker with permanent adhesive. White on black stripes have a glow-in-the-dark feature for added safety.

97ATD Anti-Theft Device

Aluminum drive rivets deter tampering with set screws as well as create a finished, aesthetic look. Drive rivets are easy to install, requiring no special tools. The drive rivet is set by striking the pin with a hammer, driving the pin flush with the rivet head and expanding the back side of the rivet. One size fits components 5-9. Rivets for components 2-4 available upon request.



Hi-Traction Covers

Improve footing and help prevent slips and falls. A variety of grip options, color, size, and materials to suit your individual project. Use in conjunction with our glow-in-the-dark Grip Tape for a complete stair system that is visible after dark or during power outages. Can be permanently installed with mechanical fasteners and/or adhesive.

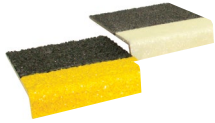

- Unique surface nearly doubles both OSHA's 0.5 and the ADA's 0.6 guide lines for Coefficient of Friction values
- Suitable for indoor and outdoor use
- Logos and directional markings can be custom printed

Hi-Traction Ladder Rung Covers

Available as both channel shaped and half-round covers made to suit rung diameters from 3/4" to 2".



KEE SAFETY Hi-Traction Stair Covers

Stair covers that cover an entire step, not just the nose, to give you the best stair traction available. 15" midsection is photo-luminescent. Made to suit.



Galvanized Steel

Schedule 40 and Schedule 80; size 1/4" to 2" IPS; nominal mill lengths of 21' cut to your projects' exact length requirements.

Aluminum

Alloy 6105-T5 with an anodized finish; size range 3/4" to 2" IPS; nominal mill lengths of 12' and 24' cut to your projects' exact length requirements.

Antimicrobial Coating

Defense against the growth of potentially harmful invisible bacteria and fungi; this powder coating can be applied in a wide range of RAL colors.

Powder Coating

Durable, corrosion preventing polyester coating applied to already galvanized/anodized products; available in any RAL color. Powder coating enhances visibility and integrates structure with building aesthetics.

pipe reference	component inner dia (in.)	nominal bore (in.)	pipe outer di. (in.)	tube outer di. (in.)
2	0.59	0.25	.54	0.531
3	0.76	0.375	.68	0.688
4	0.87	0.5	.84	0.844
5	1.09	0.75	1.05	1
6	1.38	1	1.32	1.313
7	1.72	1.25	1.66	1.625
8	1.94	1.5	1.9	1.875
9	2.41	2	2.38	2.375

Modules

Pre-assembled modules make for a simple and quick assembly or installation of your project. Provides constant barrier heights and lengths. Made to suit individual project requirements.

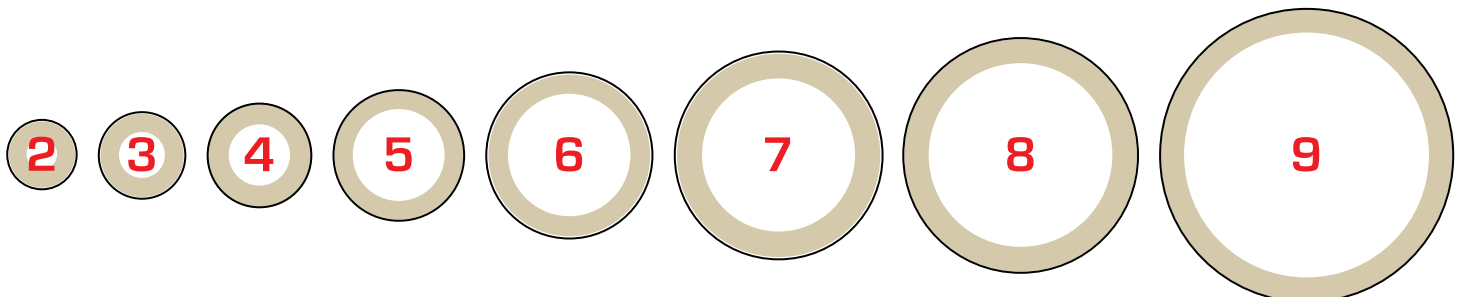

Standard Building Code

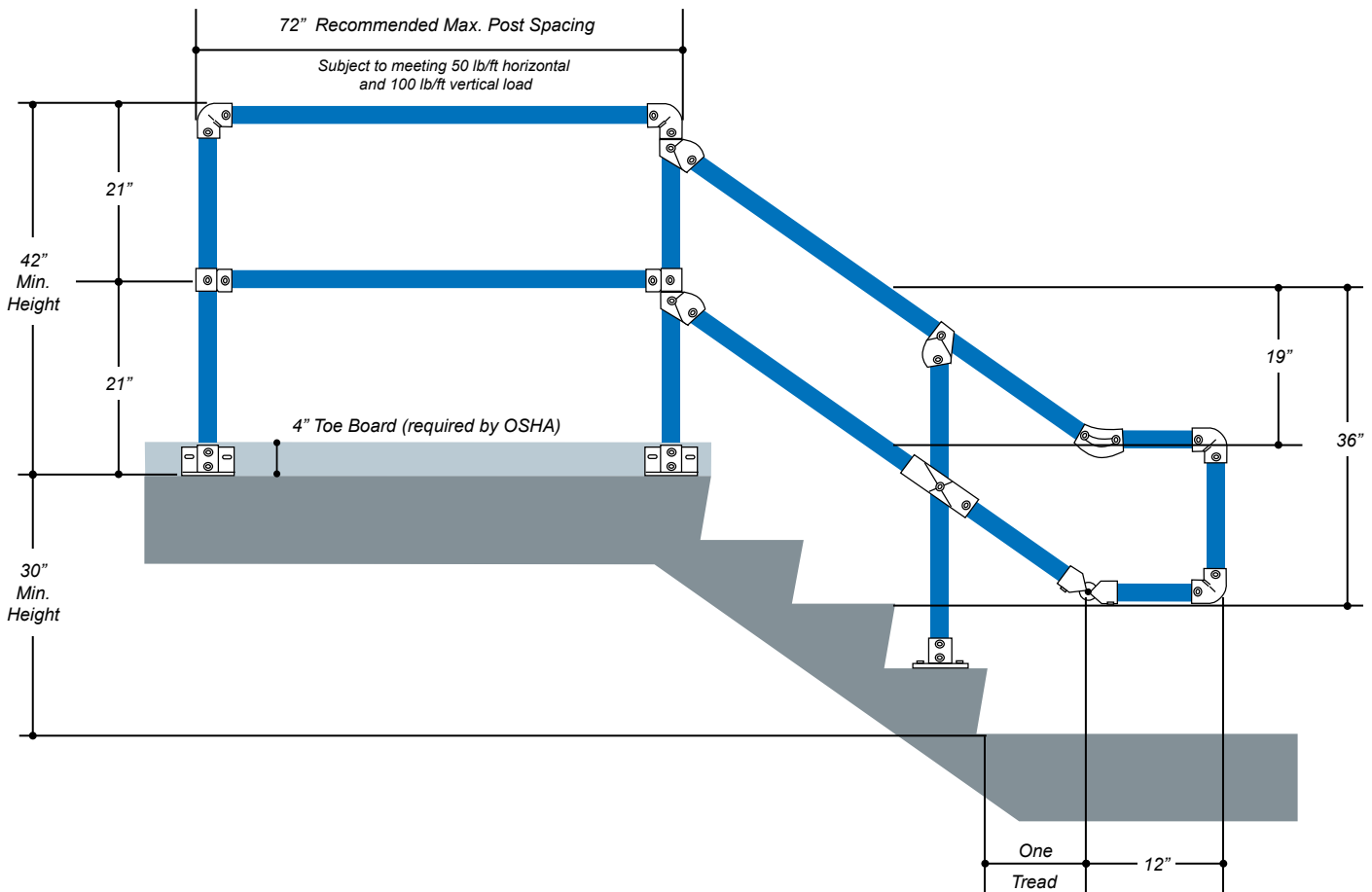

Section 1020, Business

1020.3 Handrails and guardrails. Exception: In areas not accessible to the public and in fully enclosed stairways in office buildings not serving an A, E or R occupancy, the clear distance between rails or ornamental pattern shall be such to prevent the passage of a 21-inch (533mm) diameter sphere.

Section 1022, Factory-Industrial

1022.4 Handrails and guardrails. Exception: In areas not accessible to the public in Group F, the clear distance between rails or ornamental pattern shall be such to prevent the passage of a 21-inch (533mm) diameter sphere.

Section 1023, Hazardous

1023.2 Handrails and guardrails. Exception: In areas not accessible to the public in Group H., the clear distance between rails or ornamental pattern shall be such to prevent the passage of a 21-inch (533mm) diameter sphere.

Section 1024, Institutional

1024.2.11 Handrails and guardrails. Exception: In areas not accessible to the public in Group I Restrained the clear distance between rails or ornamental pattern shall prevent the passage of a 21-inch (533mm) diameter sphere.

Section 1025, Mercantile

1025.3 Handrails and guardrails. Exception: In areas not accessible to the public and fully enclosed stairways in Group M, not serving a Group A, E or R occupancy, the clear distance between rails or ornamental pattern shall be such to prevent the passage of a 21-inch (533mm) diameter sphere.

Section 1027, Storage

1027.5 Handrails and guardrails. Exception: In areas not accessible to the public in Group S, the clear distance between rails or ornamental pattern shall be such to prevent the passage of a 21-inch (533mm) diameter sphere.

Note: Reproduced with permission Standard Building Code ©1997. The information presented on pages 38 and 39 is for guidance purposes. The user is responsible for compliance with all state, provincial, and local building codes and accessibility guidelines.

International Building Code/International Code Council

1013.1 Guards: Where Required

Guards shall be located along open-sided walking surfaces, mezzanines, industrial equipment platforms, stairways, ramps and landings which are located more than 30 inches (762 mm) above the floor or grade below. Guards shall be adequate in strength and attachment in accordance with Section 1607.7. Where glass is used to provide a guard or as a portion of a guard system, the guard shall also comply with section 2407. Guards shall also be located along glazed sides of stairways, ramps and landings that are located more than 30 inches (762 mm) above floor grade below where the glazing provided does not meet the strength and attachments in Section 1607.7.

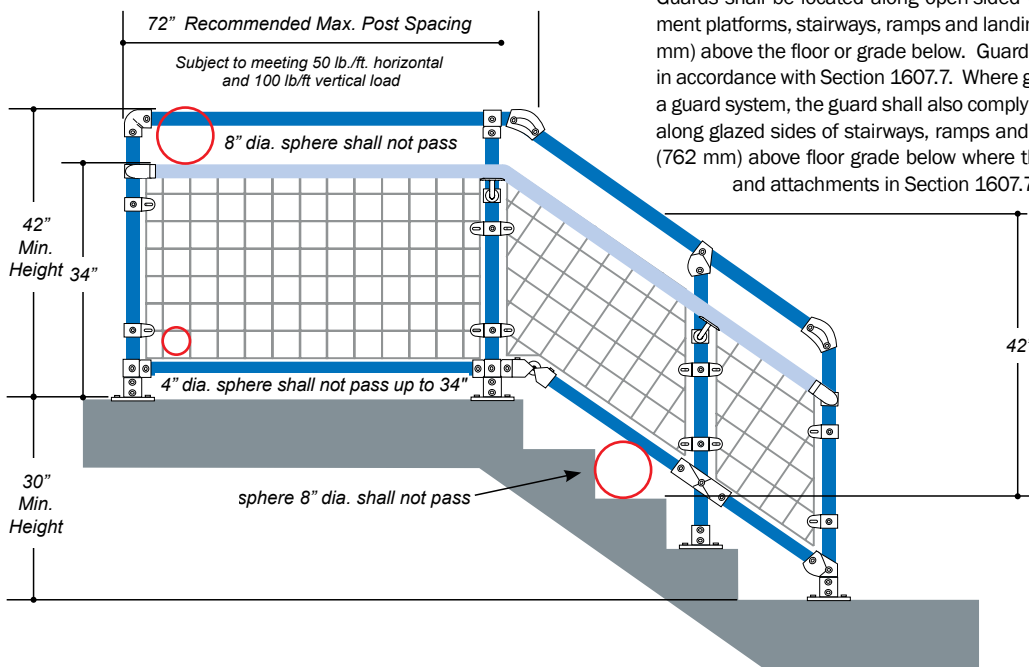

Note: Information above is non-exhaustive. The user is responsible for compliance with all state, provincial, and local building codes and accessibility guidelines. Please consult the most current publication of the following for complete IBC/ICC guidelines. Copyright 2006, International Code Council, Inc., Country Club Hills, Illinois. International Building Code 2006. Reproduced with permission. All rights reserved.

1003.2.12.1 Guards: Height

Guards shall form a protective barrier not less than 42 inches (1067 mm) high, measured vertically above the leading edge of the tread, adjacent walking surface or adjacent seatboard.

1003.2.12.2 Guards: Openings Limitations

Open guards shall have a balusters or ornamental patterns such that a 4-inch-diameter (102 mm) sphere cannot pass through any opening up to a height of 34 inches (864 mm). From height of 34 inches (864 mm) to 42 inches (1067 mm) above the adjacent walking surfaces, a sphere 8 inches (203 mm) in diameter shall not pass.

OSHA

OSHA Standard Pipe Railing: 1910.23 Guarding floor and wall openings and holes

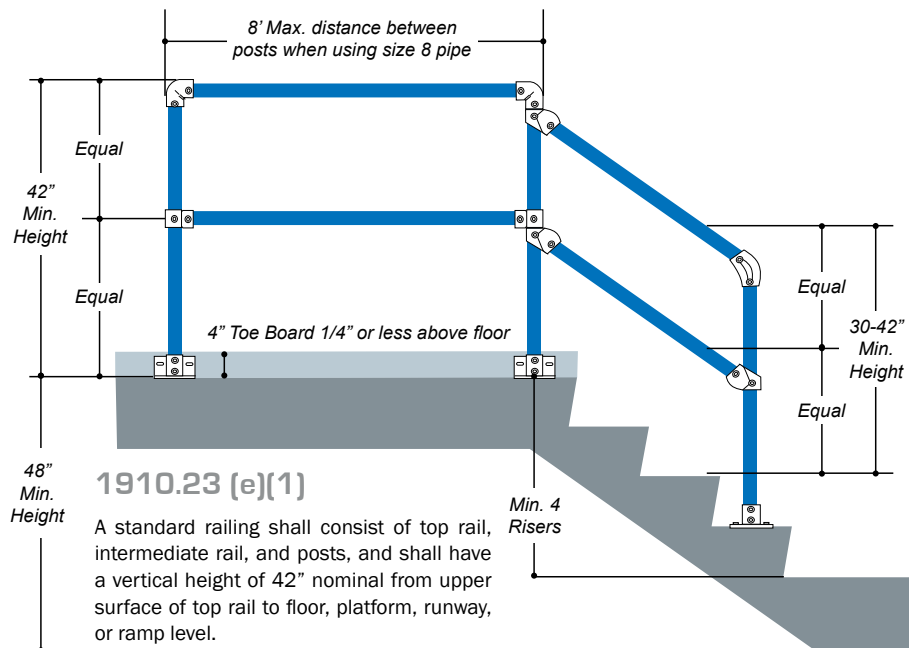

1910.23 (e) (ii)

For pipe railings, posts, and top and intermediate railings shall be at least 1-1/2" nominal diameter with posts spaced not more than 8' on centers.

1910.23 (e)[3](iv)

The anchoring of posts and framing of members for railings of all types shall be of such construction that the completed structure shall be capable of withstanding a load of at least 200 pounds applied in any direction at any point on the top rail.

1910.23 (e)[4]

A standard toe board shall be 4" nominal in vertical height from its top edge to the level of the floor, platform, runway, or ramp. It shall be securely fastened in place and with not more than 1/4" clearance above floor level. (C)[4] The railing shall be provided with the toe board wherever, (i) persons can pass, (ii) there is moving machinery, or (iii) there is equipment with which falling materials could create a hazard.

Straight and Level Guard Rail

Using Types 10, 15, 20, 21, 25, & 26,
or L10, L15, L20, L21, L25, & L26,

Where:

L = distance between centers of uprights

l = length of horizontal pipe

H = distance from ground to center line of top rail

h = length of upright pipe

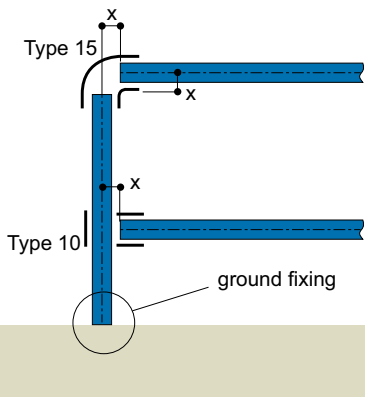
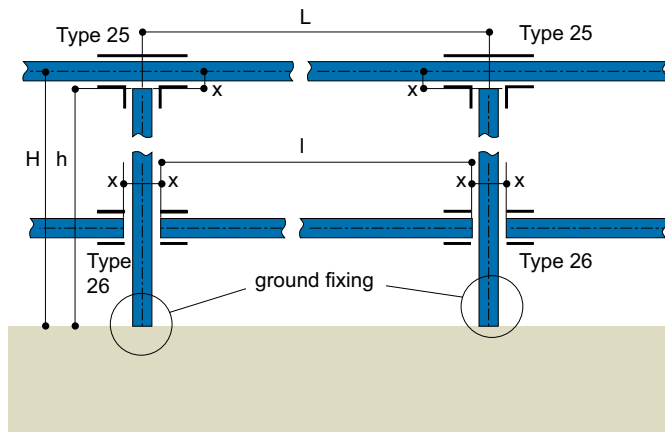

Table 1 gives details of dimension 'x' in the formula:

$$l = L - 2x$$

To calculate rail lengths and uprights use the formula:

$$h = H - x \pm (\text{ground fixing})^*$$

Table 1: Dimension 'x' for Fittings Above & Types 35, 40, & L35*

Fitting Size	x (in.)
2	- 3/8
3	- 1/2
4	- 1/2
5	- 1/2
6	- 5/8
7	- 7/8
8	- 1
9	- 1-1/8

Note: When reducing fittings are being used care must be taken to use the correct 'x' dimension. (i.e., Type 10-87, vertical pipe size 8, horizontal pipe size 7. To find the correct length of the horizontal pipe, the length 'x' is that for the size 8 vertical pipe.)

When using Types 35 and 40 the above 'x' dimension should be used.

Although guard rail is normally constructed in size 6, 7 and 8 pipe, Table 1 shows the cutting length for all KEE KLAMP pipe sizes, and can therefore be applied to many other rectangular structures.

*When using KEE LITE bases, L10, L15, L20, L21, and L26, "ground fixing" dimension will be zero.

GUARD RAIL UP SLOPES 0° - 45°

Using Machined Fittings, Types 27, 28, & 29

Where the upright remains vertical, i.e. ramps and stairways, (i) dimension 'x' to be subtracted from the upright centers dimension measured on the slope to give rail length. ($l = L - 2x$) (ii) dimension 'y' to be added to the center dimension to give the length of the upright. ($h = H + Y + \text{ground fixing}$)

Note: between angles of 30° and 45° Type 29 fitting may be used to terminate the handrail, but for angles of less than 30° use a Type 10 with the rail bent to fit.

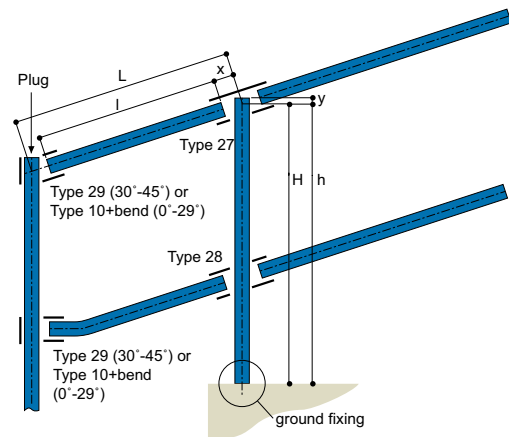

Table 2 gives details of dimensions required for calculating the rail lengths, where angles are between 0 and 45 .

Table 2: Rails

Angle of Slope	Size 6 Fittings: 'x' (in)	Size 7 Fittings: 'x' (in)	Size 8 Fittings: 'x' (in)
0 to 4	- 3/4	- 7/8	- 1
5 to 9	- 7/8	- 1	- 1-1/8
10 to 11	- 1	- 1-1/8	- 1-1/4
15	- 1	- 1-1/4	- 1-3/8
20	- 1-1/8	- 1-1/4	- 1-1/2
25	- 1-1/4	- 1-3/8	- 1-5/8
30	- 1-3/8	- 1-5/8	- 1-3/4
35	- 1-1/2	- 1-3/4	- 2
40	- 1-5/8	- 1-7/8	- 2-1/4
45	- 1-7/8	- 2-1/8	- 2-1/2

Table 3 gives details of dimensions required for calculating the upright lengths, where angles are between 0 and 45 .

Table 3: Uprights

Angle of Slope	Size 6 Fittings: 'y' (in)	Size 7 Fittings: 'y' (in)	Size 8 Fittings: 'y' (in)
0 to 4	+ 3/4	+ 7/8	+ 1
5 to 9	+ 5/8	+ 3/4	+ 3/4
10 to 11	+ 5/8	+ 5/8	+ 3/4
15	+ 1/2	+ 5/8	+ 3/4
20	+ 1/2	+ 1/2	+ 5/8
25	+ 3/8	+ 1/2	+ 5/8
30	+ 3/8	+ 1/2	+ 1/2
35	+ 3/8	+ 3/8	+ 1/2
40	+ 1/4	+ 3/8	+ 3/8
45	+ 1/4	+ 1/4	+ 3/8

GUARD RAIL UP SLOPES 0° - 11°

Using Types 86, 87, 88 and 89- size 8 only

Where the upright remains vertical, i.e., ramps and stairways, (i) dimension 'x' to be subtracted from the upright centers dimension measured on the slope to give rail length. ($l = L - 2x$), (ii) dimension 'y' to be added to the center dimension to give the length of the upright. ($H = h + y + \text{ground fixing}$)

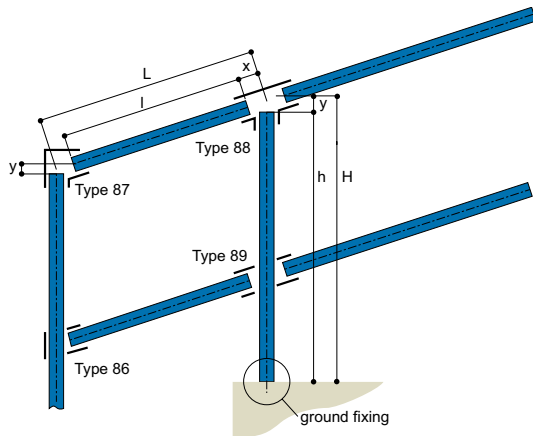

Table 4 gives details of dimensions required for calculating the rail lengths, where angles are between 0° and 11°.

Table 4: Rails

Angle of Slope	Size 8 Fittings: 'x' (in)
0 to 4	- 1
5 to 9	- 1-1/8
10 to 11	- 1-1/4

Table 5 gives details of dimensions required for calculating the upright lengths, where angles are between 0° and 11°.

Table 5: Uprights

Angle of Slope	Size 8 Fittings: 'y' (in)
0 to 4	- 1
5 to 9	- 1-1/8
10 to 11	- 1-1/4

GUARDRAILING UP SLOPES 30°-45°

Using Adjustable Fittings, Types 29, 30, 55 & 56, or Types L29 & L30 size 6, 7 and 8

Where the upright remains vertical, i.e., stairways (i) dimension x, y, or z to be subtracted from the upright centers. Dimension (L), to give the length of rail. (ii) dimension u, v and w for determining the upright length.

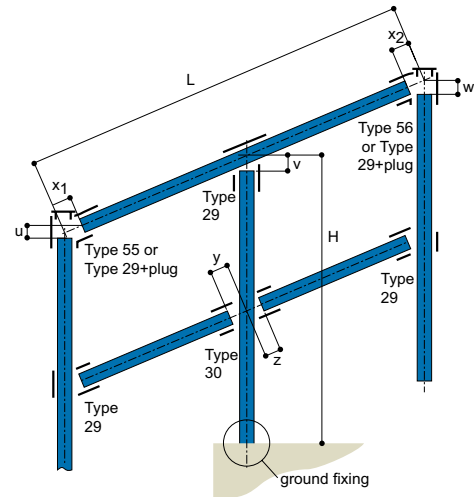

Table 6 gives details of dimensions required for calculating the rail lengths, where angles are between 30 and 45°.

Table 6: Rails

Angle of Slope	Size 6 Fittings:			Size 7 Fittings:			Size 8 Fittings:		
	x (in)	y (in)	z (in)	x (in)	y (in)	z (in)	x (in)	y (in)	z (in)
30	- 1-1/4	- 2-1/8	- 1-3/8	- 1-5/8	- 2-1/2	- 1-5/8	- 1-3/4	- 3	- 2-1/8
35	- 1-3/8	- 2	- 1-1/2	- 1-3/4	- 2-3/8	- 1-3/4	- 2	- 2-7/8	- 2-1/4
40	- 1-1/2	- 1-7/8	- 1-5/8	- 1-7/8	- 2-1/4	- 1-7/8	- 2-1/8	- 2-1/2	- 2-3/8
45	- 1-3/4	- 1-3/4	- 1-3/4	- 2-1/8	- 2	- 2	- 2-3/8	- 2-1/2	- 1-5/8

Table 7 gives details of dimensions required for calculating the upright lengths, where angles are between 30 and 45°.

Table 7: Uprights

Angle of Slope	Size 6 Fittings:			Size 7 Fittings:			Size 8 Fittings:		
	u (in)	v (in)	w (in)	u (in)	v (in)	w (in)	u (in)	v (in)	w (in)
30	+ 1-3/8	- 1-1/4	+ 1	+ 1-3/4	- 1-5/8	+ 1-1/8	+ 1-7/8	- 1-3/4	+ 1-1/4
35	+ 1-5/8	- 1-3/8	+ 3/4	+ 2	- 1-3/4	+ 7/8	+ 2-1/8	- 2	+ 1
40	+ 1-7/8	- 1-1/2	+ 1/2	+ 2-3/8	- 1-7/8	+ 1/2	+ 2-1/2	- 2-1/8	+ 1/2
45	+ 2-1/4	- 1-3/4	+ 1/8	+ 2-3/4	- 2-1/8	+ 1/8	+ 3	- 2-3/8	+ 1/8

Table 7 gives details of dimensions required for calculating the upright lengths, where angles are between 30 and 45°.

Table 8: Uprights and Rails using Types 55 and 56 - Size 8 Only

Angle	u (in)	x ₁ (in)	w (in)	x ₂ (in)
20 to 29	- 3/4	- 3/4	- 2	- 2
30 to 39	- 5/8	- 5/8	- 2-3/8	- 2-3/8
40 to 49	- 1/2	- 1/2	- 2-3/4	- 2-3/4
50 to 59	- 1/2	- 1/2	-	-
60 to 69	- 3/8	- 3/8	-	-
70 to 79	- 3/8	- 3/8	-	-
80 to 88	- 1/4	- 1/4	-	-

Shelving

Using Type 46 or L46

Shelving with carrying rails positioned on the outside of the upright.

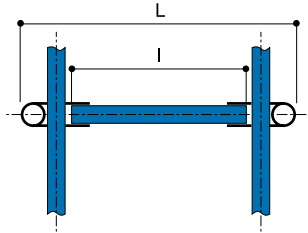

Table 9 gives the dimension 'x' to be subtracted from overall shelf width 'L' to give the length of the cross rail in the formula $l = L - x$. (Dim. x accounts for the use of two Type 46 or L46 fittings.)

Table 9:

Fitting Size	x (in.)
4	- 3-7/8
5	- 5-1/4
6	- 6-3/8
7	- 7-3/4
8	- 9
9	- 10-7/8

Construction of Braces and Struts

Using Types C50, C51, & C52, or LC50, LC51, & LC52

When using multiple pipe sizes in one structure, Types F50-5 to F50-9 or LF50-6 to LF50-8 can all be combined with:

M50-5 to M50-9 LM50-6 to LM50-8

M51-5 to M51-9 LM51-6 to LM51-8

M52-5 to M52-8 LM52-6 to LM52-8

to construct combination fittings, (i.e., C50-75, C50-85, C51-655 and C52-855.)

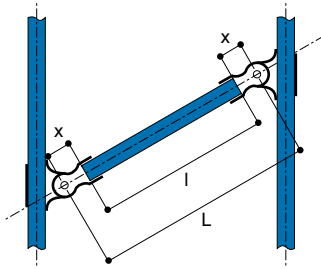

Table 10 gives details of dimension 'x' to be subtracted to give the pipe length required for use with two Type F50 or LF50 fittings in the formula $l = L - 2x$.

Table 10:

Fitting Size	x (in.)
4	- 1/2
5	- 1
6	- 1
7	- 1
8	- 1
9	- 1-1/4

Note: Dimension 'L' is the length from pivot point to pivot point. The distance from upright to upright is dependent on the angle of the strut.

PALLET RACKING

Using Type 46 or L46

Pallet racking with the carrying rails on the inside of the upright.

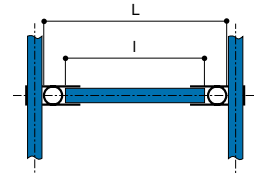

Table 11 gives dimension 'x' which must be subtracted from the overall width of the carrying rails, to give the length of the cross rail in the formula: $l = L - x$. (Dim. x accounts for the use of two Type 46 or L46 fittings.)

Table 11:

Fitting Size	x (in.)
4*	- 1-7/8
5*	- 2-3/8
6*	- 7-7/8
7	- 3-3/8
8	- 4
9	- 5

*Pallet racking is not recommended in less than size 7 pipe.

The length of the longitudinal member can be calculated from multiples of the length of the bay between the centers of uprights, plus dimension 'z' in Table 12. Dimension z accounts for the length of pipe needed to go through topmost fitting to the fitting's termination. This applies to constructions using fitting Type 45 also.

Table 12: Additional Pipe Length to Reach Topmost Fitting's Termination.

Fitting Size	z (in.)
3	+ 1
4	+ 1-1/8
5	+ 1-1/4
6	+ 1-1/2
7	+ 1-7/8
8	+ 2
9	+ 2-3/8

Longitudinal pipes are joined using fittings Type 14 or 18 couplings, (use of Type 18 not recommended as a load bearing joint,) which must be positioned to occur at the edge of the Type 46 fitting, and must not all occur in the same bay at alternate levels.

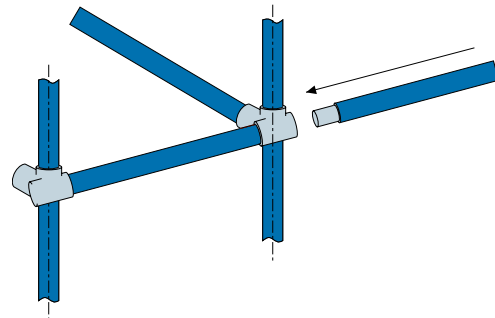

Spigots can be either pipes or rods, riveted into position, or the Type 18 fitting. When using the latter, a gap of 3/4" must be allowed for the set screw fixing.

Base and Wall Fixings*

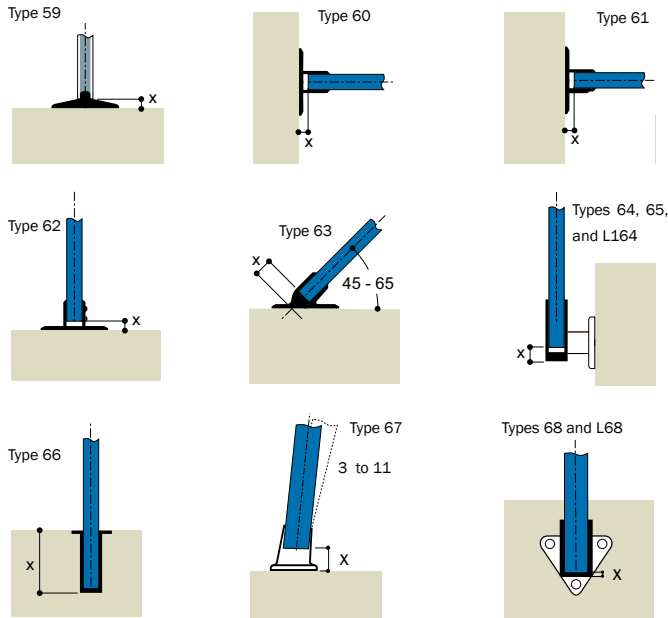

Table 13 gives details of the ground fixing dimension 'x', to be subtracted from the height 'H' to give the length of the upright 'h'.

Table 13:

Flange Type	x (in.)
59	- 3/8
60	- 3/8
61	- 1/4
62	- 1/4
67	- 1/4

Table 14 gives details of the ground fixing dimension 'x', for Type 63-6 only, to be subtracted to give the length of the upright for each angle condition.

Table 14:

Angle	x (in.)
45	- 1-1/2
50	- 1-1/4
60	- 1
65	- 1/2

Table 15 gives the dimension 'x' to be subtracted from the length of the upright for fittings, Types 64, 65, 67, 68, L68, and L164.

Table 15:

Fitting Size	x (in.)
6	- 1/4
7	- 1/4
8	- 1/4

Table 16 gives the ground fixing dimension 'x', to be added to the upright member to allow for the setting into the socket Type 66.

Table 16:

Fitting Size	x (in.)
6	+ 4-1/2
7	+ 5
8	+ 5

*When using KEE LITE bases and flanges, "ground fixing" dimension (x) will be zero, except when using flanges L164, L68, and LC58.

Constructing Circles and Triangles

Slopes and radii present no problem to the KEE KLAMP galvanized railing systems. Fitting Types 27, 28, 29, 30, C50, C51, C52, 55, 56, 86, 87, 88 and 89 and the 90 range pedestrian guard rail fittings are designed to allow for raked handrail while keeping the uprights vertical. Pipe can be bent and radiused to suit most situations. Also, true lengths have to be determined where braces and struts are being used.

To enable KEE SAFETY to machine fittings and radius pipe some basic information is required, (e.g., angle of slope, arc lengths, etc.). We have provided simple formulas and work examples to help you solve individual problems.

Machined Fittings

Types 27 and 28 are held in stock as blanks. These are then machined to individual requirements. It is therefore essential when ordering that the required angle from the horizontal is stated. Other pipe lengths need to be determined when using fitting Types 29 and 30, C50, C51 and C52 and the 90 range pedestrian guard rail fittings.

Worked Example

Consider the following concrete single flight staircase.

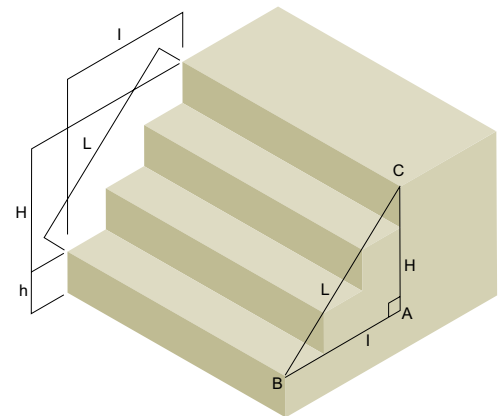

Where

H = Vertical height from 1st nosing to last nosing.

h = Vertical height from ground level to 1st nosing.

I = Horizontal dimension from 1st nosing to last nosing.

L = Hypotenuse dimension (Pitch Line) from 1st nosing to last nosing.

Known Data	Formula for Side and Angle		
H & L	$I = \sqrt{L^2 - H^2}$	$\sin B = \frac{H}{L}$	$C = 90^\circ - B$
L & I	$H = \sqrt{L^2 - I^2}$	$\sin C = \frac{I}{L}$	$B = 90^\circ - C$
H & I	$L = \sqrt{H^2 + I^2}$	$\tan B = \frac{H}{I}$	$C = 90^\circ - B$

Note: The table can be used to solve angles and true lengths for braces and struts.

Step 1

From a simple site survey or information from a working drawing, obtain the following dimensions.

Note: For greater accuracy vertical dimensions should be taken by means of a Dumpy Level or a Theodolite.

H = vertical height from the 1st nosing to the last (55 in).

L = pitch line, the diagonal dimension from the 1st nosing to the last (96 in).

Step 2

From the table to determine angle B we use;

$\sin B = 55 / 96$, Angle B = 35°

Ramps can be dealt with in a similar way. Most ramps have a stated gradient e.g. 1:12, for every 12 units traversed horizontally, 1 unit of vertical height is obtained.

How to Make Jigs for Railing Posts: Set-up

Step 1: Start with pre-cut pipe.

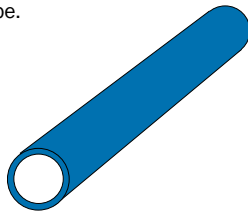

Step 2: Measure and locate fittings on first post only.

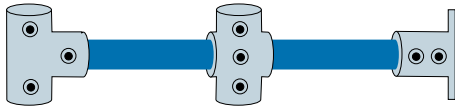

Step 3: Lay post horizontal, and insert two pieces of scrap pipe. This is all that's involved in setting up your jig! From this point, duplicate posts can be produced by unskilled labor, without further measuring, at the rate of 20-30 posts per hour.

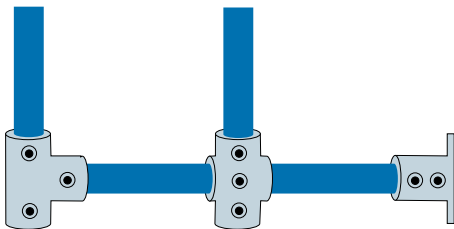

Utilizing Jigs for Railing Posts: Production

Step 1: Set top and middle fittings in place, unfastened, on the two pieces of scrap pipe.

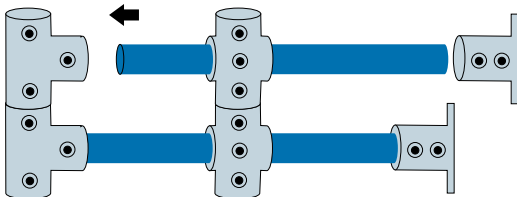

Step 2: Insert pre-cut pipe into fittings, then add flange.

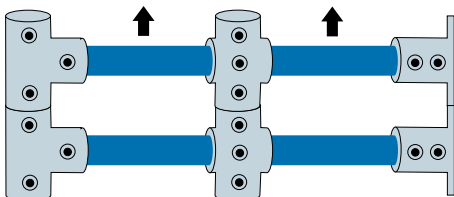

Step 3: Simply tighten set screws, then lift off.

Aluminum Racking Load Tables

Table 17: Aluminum beam load table (lbs.)

Span	Fitting Size			
	6	7	8	9
	Pipe Size			
	1" N.B.	1-1/4" N.B.	1-1/2" N.B.	2" N.B.
1'	3081	3413	10369	17966
2'	984	2198	3494	7510
3'	438	975	1551	3337
3' 6"	321	717	1141	2453
4'	245	548	872	1877
4' 6"	-	434	690	1483
5'	-	352	557	1200
5' 6"	-	291	462	992
6'	-	243	386	833
6' 6"	-	208	329	710
7'	-	178	283	613
7' 6"	-	-	248	534
8'	-	-	217	469
9'	-	-	171	370
10'	-	-	-	300

Table reflects a safety factor of 2:1

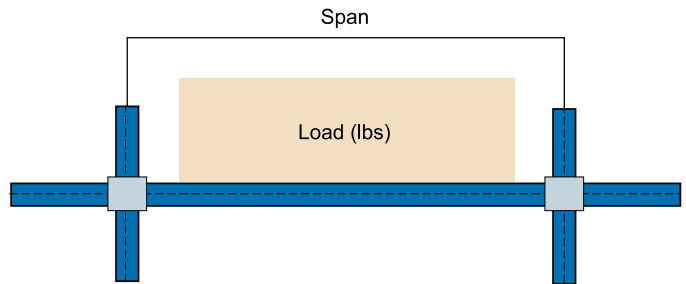

The values in Table 17 are an indication of a UDL that a rack consisting of two support pipes can support.

For uneven load distributions the required tube size must be determined by standard bending moment and deflection calculations assuming the KEE LITE joint to give a simply supported beam.

At loads greater than 1700 lbs.* consideration must be given to set screw slip. (*rating includes a safety factor of 2:1)

Table 18: Load table (lbs.) - unfixed upright

Span	Fitting Size			
	6	7	8	9
	Pipe Size			
	1" N.B.	1-1/4" N.B.	1-1/2" N.B.	2" N.B.
1'	5359	9201	11573	16274
1' 3"	3644	7651	10126	15418
1' 6"	2858	5811	8101	14639
1' 9"	1965	4358	6944	13082
2'	1107	3390	5381	11291
2' 3"	893	2808	4340	8487
2' 6"	714	1598	3761	7397
2' 9"	589	1307	2777	6073
3'	553	1113	2488	5295
3' 3"	464	1017	2198	4516
3' 6"	393	871	1157	4282
3' 9"	-	774	1099	3504
4'	-	726	868	3192
4' 3"	-	678	839	2803
4' 6"	-	629	787	1635
4' 9"	-	-	693	1323
5'	-	-	608	1227
5' 3"	-	-	-	1168
5' 6"	-	-	-	1027
5' 9"	-	-	-	973
6'	-	-	-	894
6' 3"	-	-	-	814
6' 6"	-	-	-	774
6' 9"	-	-	-	-
7'	-	-	-	-

Table reflects a safety factor of 2:1

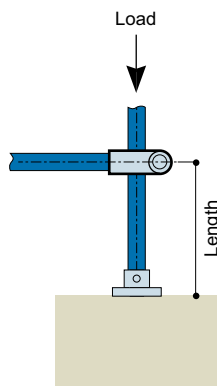

Table 18 gives an indication only of the safe load, in pounds, that may be carried between the above restraints by single Schedule 40 pipe when used as uprights.

At loads greater than 1700 lbs.* consideration must be given to set screw slip. (*rating includes a safety factor of 2:1)

Table 19: Load table (lbs.) - fixed uprights

Span	Fitting Size			
	6	7	8	9
	Pipe Size			
	1" N.B.	1-1/4" N.B.	1-1/2" N.B.	2" N.B.
1'	7825	11138	13367	18299
1' 3"	7432	10557	13020	17909
1' 6"	6967	10412	12615	17754
1' 9"	5788	9685	12152	17286
2'	5288	9201	11573	16975
2' 3"	4430	8329	11284	16352
2' 6"	3859	7506	10589	15573
2' 9"	3037	6537	9143	15418
3'	2679	5714	7985	14561
3' 3"	2429	4939	7407	13627
3' 6"	2072	4261	6828	12848
3' 9"	1858	4068	5960	12069
4'	-	3390	5497	11291
4' 3"	-	3147	4918	10512
4' 6"	-	2905	4340	8721
4' 9"	-	2663	3935	8409
5'	-	2373	3587	7631
5' 3"	-	2179	3356	6852
5' 6"	-	-	3182	6073
5' 9"	-	-	2835	5606
6'	-	-	2604	5295
6' 3"	-	-	-	5061
6' 6"	-	-	-	4750
6' 9"	-	-	-	4516
7'	-	-	-	3971
7' 3"	-	-	-	3815
7' 6"	-	-	-	3504
7' 9"	-	-	-	3348
8'	-	-	-	-
8' 3"	-	-	-	-

Table reflects a safety factor of 2:1

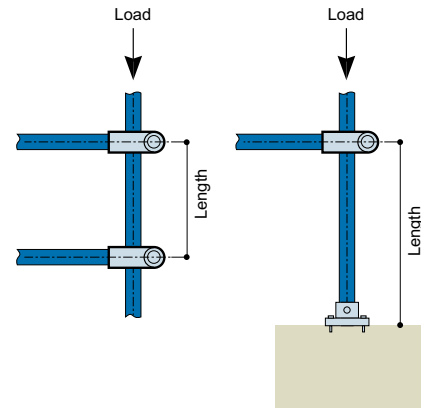

Table 19 gives an indication only of the safe load, in lbs., that may be carried between the above restraints by single Schedule 40 pipes when used as uprights.

At loads greater than 1700 lbs.* consideration must be given to set screw slip. (*rating includes a safety factor of 2:1)

Galvanized Racking Load Tables

Table 17: Beam load table (lbs.)

Span	Fitting Size				
	5	6	7	8	9
	Pipe Size				
	3/4" N.B.	1" N.B.	1-1/4" N.B.	1-1/2" N.B.	2" N.B.
1'	1658	3123	5516	7669	13180
2'	829	1562	2758	3834	6590
3'	553	1041	1838	2556	4393
3' 6"	474	892	1576	2191	3766
4'	414	781	1379	1917	3295
4' 6"	368	694	1226	1704	2929
5'	332	625	1103	1534	2636
5' 6"	302	568	1003	1394	2396
6'	277	520	919	1278	2197
6' 6"	255	481	849	1180	2028
7'	237	446	788	1096	1883
7' 6"	221	417	735	1023	1757
8'	207	390	690	959	1648
9'	184	347	613	852	1464
10'	166	313	551	767	1318

Table reflects a safety factor of 1.67:1

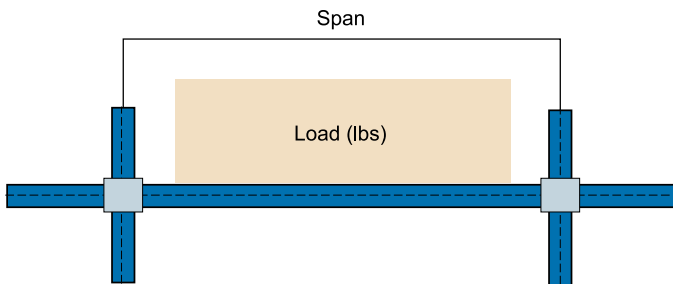

Table 17 gives an indication only of the safe load, uniformly distributed, in pounds, that may be carried by shelf consisting of front and back pipes when used as continuous beams.

For uneven load distributions or single spans, the required pipe size must be determined by standard bending moment calculations assuming a Kee Klamp joint to give a simply supported beam.

At loads greater than 2000 lbs.* consideration must be given to set screw slip. (*rating includes a safety factor of 2:1)

Table 18: Load table (lbs.) - un-fixed upright

Span	Fitting Size				
	5	6	7	8	9
	Pipe Size				
	3/4" N.B.	1" N.B.	1-1/4" N.B.	1-1/2" N.B.	2" N.B.
1'	1868	3243	4445	5238	7738
1' 3"	1633	2958	4213	4955	7398
1' 6"	1420	2673	3875	4650	7160
1' 9"	1213	2375	3630	4395	6785
2'	995	2108	3335	4138	6448
2' 3"	840	1813	3048	3883	6210
2' 6"	700	1583	2753	3570	5848
2' 9"	603	1395	2505	3243	5575
3'	-	1220	2170	2985	5180
3' 3"	-	1078	1993	2698	4863
3' 6"	-	948	1810	2418	4525
3' 9"	-	-	1643	2250	4218
4'	-	-	1488	2065	3880
4' 3"	-	-	1313	1880	3675
4' 6"	-	-	1215	1698	3303
4' 9"	-	-	-	1560	3123
5'	-	-	-	1450	2918
5' 3"	-	-	-	-	2693
5' 6"	-	-	-	-	2523
5' 9"	-	-	-	-	2398
6'	-	-	-	-	2150
6' 3"	-	-	-	-	2048
6' 6"	-	-	-	-	1878
6' 9"	-	-	-	-	-
7'	-	-	-	-	-

Table reflects a safety factor of 2:1

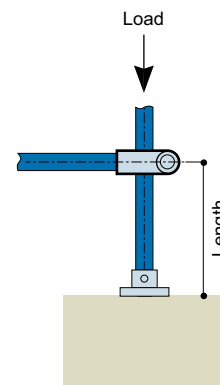

Table 18 gives an indication only of the safe load, in pounds, that may be carried between the above restraints by single Schedule 40 pipe when used as uprights.

At loads greater than 2000 lbs.* consideration must be given to set screw slip. (*rating includes a safety factor of 2:1)

Test Report:

Vibration of Kee Klamp® Assemblies

Exhaustive tests on samples of standard size 7 KEE KLAMP fittings were performed by an independent research laboratory. The purpose of the test was to evaluate the use of either standard set screws or self-locking set screws.

Test Arrangement

A "Tee" section test assembly was made using three 12 ft. lengths of galvanized size 7 standard pipe held together by a three socket tee fitting (Type 25-7). The vertical leg of the test assembly was supported in a standard railing flange (Type 62-7). The completed assembly was then rigidly attached to the vibration table.

The test assembly was initially assembled using standard set screws and tested in this configuration. The standard set screws were then replaced with the self-locking screws and the tests repeated.

Test Procedure

The test was conducted on a Ling 667 kg Electromagnetic vibration table. The table was programmed to perform a resonance search between 25 and 350 Hz. and resonant frequencies were recorded and shown in Table 20.

During the resonance search amplification factors, Q, were measured at each resonant frequency, the point of reference being the end of one horizontal pipe. The table was then held at one of the resonant frequencies, set in motion with a controlled

Table 19: Load table (lbs.) - fixed uprights

Span	Fitting Size				
	5	6	7	8	9
	Pipe Size				
	3/4" N.B.	1" N.B.	1-1/4" N.B.	1-1/2" N.B.	2" N.B.
1'	2045	3390	4635	5403	7975
1' 3"	1855	3183	4445	5235	7635
1' 6"	1633	2958	4213	4955	7443
1' 9"	1493	2705	3948	4730	7160
2'	1283	2480	3715	4500	6843
2' 3"	1058	2245	3470	4268	6685
2' 6"	953	2020	3273	4003	6355
2' 9"	823	1780	2993	3730	6063
3'	700	1583	2703	3523	5835
3' 3"	635	1435	2563	3283	5520
3' 6"	-	1288	2283	3083	5270
3' 9"	-	1160	2085	2858	4978
4'	-	1025	1938	2603	4818
4' 3"	-	-	1783	2393	4503
4' 6"	-	-	1643	2225	4218
4' 9"	-	-	1488	2098	3958
5'	-	-	1363	1920	3675
5' 3"	-	-	1270	1785	3415
5' 6"	-	-	-	1698	3268
5' 9"	-	-	-	1520	3088
6'	-	-	-	1450	2918
6' 3"	-	-	-	-	2715
6' 6"	-	-	-	-	2578
6' 9"	-	-	-	-	2398
7'	-	-	-	-	2263
7' 3"	-	-	-	-	2150
7' 6"	-	-	-	-	2048
7' 9"	-	-	-	-	1913
8'	-	-	-	-	-
8' 3"	-	-	-	-	-

Table reflects a safety factor of 2:1

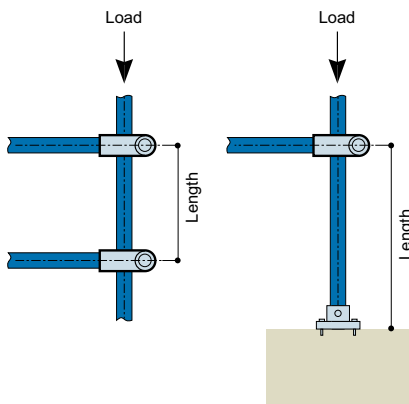

Table 19 gives an indication only of the safe load, in lbs., that may be carried between the above restraints by single Schedule 40 pipes when used as uprights.

At loads greater than 2000 lbs.* consideration must be given to set screw slip. (*rating includes a safety factor of 2:1)

Table 20: Test Results

Resonance Frequencies	Q Factor	Running Time
74	1.27	Nil
106	1.27	Nil
158	1.53	6 hours
200	1.8	6 hours
221	5	6 hours
295	9	6 hours

During the twenty-four hours of vibration at the four resonant frequencies above no signs of loosening with either type of attachment screw occurred.

Telescopic Relationship: The telescopic relationship between Schedule 40 and Schedule 80 steel pipe.

2"	Schedule 40	will accept 1 1/2" Schedule 40 or 80
	Schedule 80	will accept 1 1/2" Schedule 40 or 80
1-1/2"	-	no telescopic relationship,
	-	requires special spigotting material
1-1/4"	Schedule 40	will accept 1" Schedule 40 or 80
	Schedule 80	no telescopic relationship, requires special spigotting material
1"	-	no telescopic relationship,
	-	requires special spigotting material
3/4"	-	no telescopic relationship,
	-	requires special spigotting material
1/2"	-	no telescopic relationship,
	-	requires special spigotting material
3/8"	-	no telescopic relationship,
	-	requires special spigotting material
1/4"	-	no telescopic relationship,
	-	requires special spigotting material



KEE SAFETY components allow for a wide range of flexibility and versatility to create strong, safe and durable solutions that are sound for many uses. In this gallery are just a few of the many applications possible with the wide range of safety components available from KEE SAFETY. Visit www.keesafety.com/us to view more resources and ideas for your custom safety solution.



Left:

Powder Coated Safety
Guardrail

Below:

Waste Water Treatment Safety Guardrail

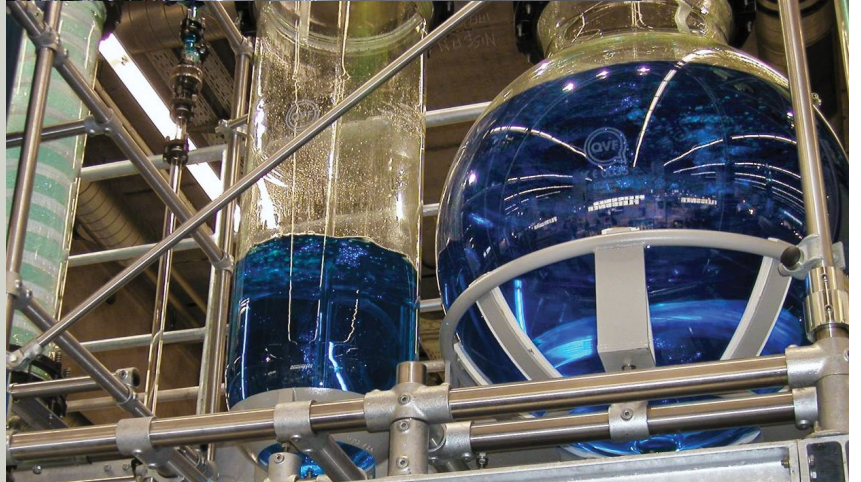

Photo by Michael Fielding.
Courtesy of *Public Works*.

Right:
ADA Compliant Railing for
Public Access



Right:
Industrial Process Plant Structures



Right:
ADA Compliant Railing for Access Ramps



Right:
Warehouse and Manufacturing
Safety Screen



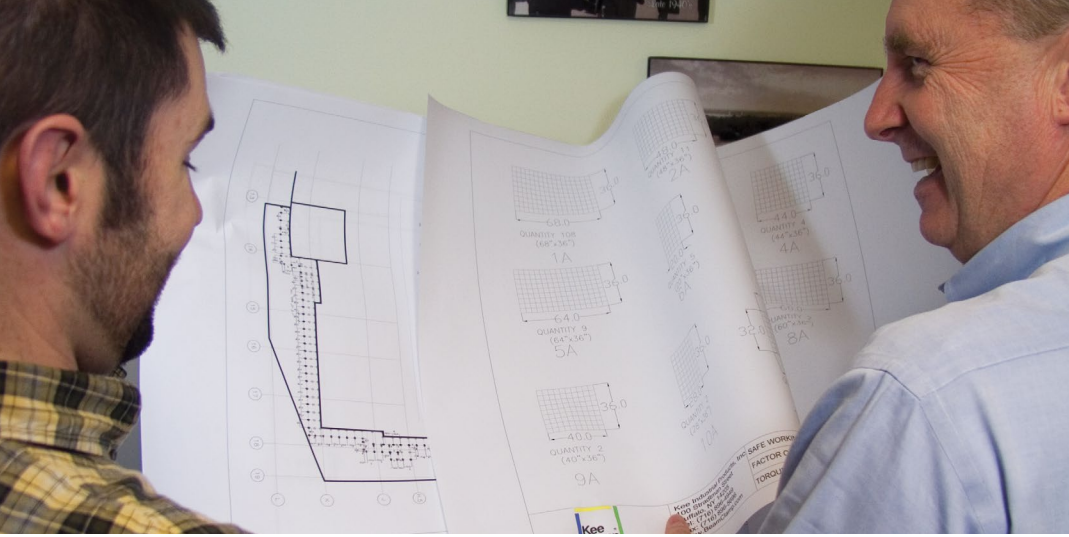

providing design and installation services for compliant safety railing solutions

Turnkey Safety Solutions

We at KEE SAFETY have dedicated construction professionals who have worked within the construction industry for many years. Together with their expert industry knowledge and our safety product ranges, our team is fully capable of providing you with safety guardrail and handrail solutions that will service your project needs.

Whether dealing with new, refurbishment or upgrading of existing structures and developments, we can provide safety compliant guardrail and handrail designs, whether it be internal, external, at ground level, or roof level.

We can also advise you on project costs, manage completion time scales from inception to meet your site requirements, and also ensure compliance of our systems with current North American Legislation and Safety requirements.

Custom Services

Our dedicated technical service team can provide advice and solutions. We have CAD facilities and design software to enable us to interpret your design requirements and provide you with a solution.

We can visit the location to execute a full inspection including a measuring service so that the correct information is gathered. Furthermore, we are able to provide a full installation service to assist in meeting any deadlines and site needs. Our installation teams are professional and excel in the assembly of our safety systems.

Cost Estimates Specific to Project Needs

Technical Advice and Solutions Support

Site Inspection Service

Design Solutions in CAD

Installation Services to Meet Your Site Deadlines

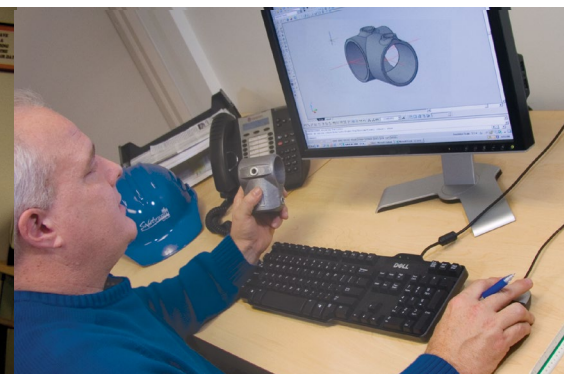
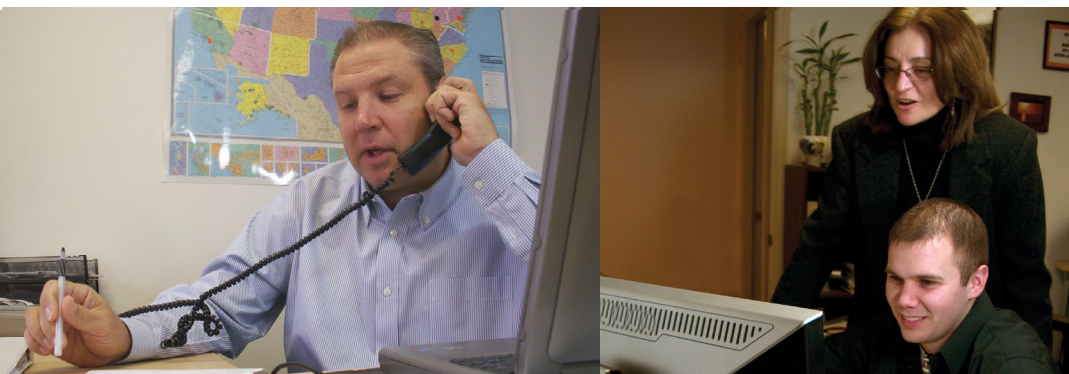

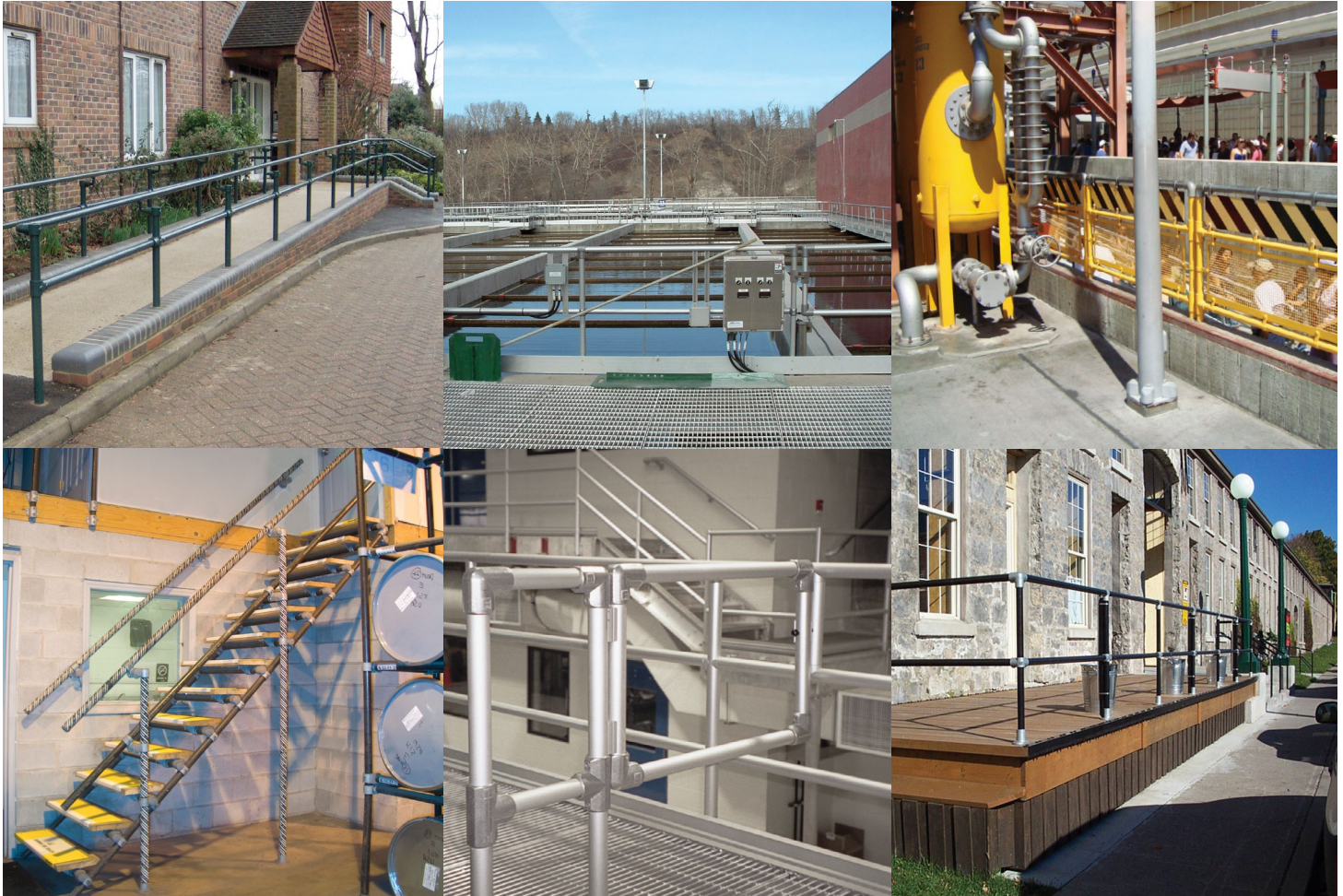

Canada
 Kee Safety, Ltd.
 40 North Rivermeade Road, Units 6 & 7
 Concord, Ontario L4K 2H3
 Tel: (905) 669 1494
 Fax: (905) 669 4347
 Toll Free: (877) 505 5003